

Building Envelope Technology Symposium 2014



Tampa, Florida
October 20-21, 2014

THE FUNDAMENTALS OF ENERGY CONSERVATION DESIGN

Karim Allana, PE, RRC, RWC

Allana Buick & Bers, Inc.



Copyright Materials

This presentation is protected by US and International copyright laws.

Reproduction, distribution, display and use of the presentation without written permission of the speaker is prohibited.

Allana Buick & Bers, Inc. 2020



ALLANA BUICK & BERS
Making Buildings Perform Better



Best Practice

Allana Buick & Bers, Inc. (ABBAE) is a Registered Provider with the American Institute of Architects Continuing Education Systems. Credit earned on completion of this program will be reported to CES Records for AIA members. Certificates of completion for non-AIA members are available on request.

This program is registered with the AIA/CES for continuing professional education. As such, it does not include content that may be deemed or construed to be an approval or endorsement by the AIA of any material of construction or any method or manner of handling, using, distributing, or dealing in any material or product. Questions related to specific materials, methods, and services will be addressed at the conclusion of this presentation.



Karim P. Allana, PE, RRC, RWC

- **Education:** B.S., Civil Engineering, Santa Clara University
- **Registration:** P.E., Civil Engineering, California, Washington, Nevada, and Hawaii
- **Certification:** Registered Roof Consultant (RRC), Roof Consultants Institute, and Registered Waterproofing Consultant (RWC)
- **Overview:**
 - CEO and Senior Principal at Allana Buick & Bers.
 - Former Turner Construction Employee (Project Engineering and Superintendent)
 - Over 37 years experience providing superior technical standards in all aspects of building technology and energy efficiency.
 - Principal consultant in forensic investigations of building assemblies, failure analysis, evaluation and design of building infrastructure and building envelope evaluation and design.
 - Expert in all aspects of building envelope technology.
 - Completed numerous new construction, addition, rehabilitation, remodel and modernization projects for public and private sector clients.
 - Specialization in siding, roofing, cement plaster, wood, water intrusion damage, window assemblies, storefronts, below grade waterproofing, energy efficiency, solar engineering and complex building envelope and mechanical assemblies.



ABBAE Firm Overview

- Allana Buick & Bers (ABBAE) is an Architectural Engineering firm specializing in Building Envelope Systems
- ABBAE is one of the 5 largest building envelope consultants in the country
- ABBAE has over 33 years of experience & over 12,500 projects
- ABBAE is also a leading Forensic Defect firm with hundreds of forensic projects (litigation)
- Locations – 16 offices across California, Nevada, North Carolina, Oklahoma, Oregon, Texas, Virginia, Washington, Colorado and Hawaii



Staff & In-House Expertise

- Licensed Professional Engineers – Civil, Structural, and Mechanical
- Registered Architects
- Building Enclosure Commissioning Process Providers (BECxPs)
- Registered Building Envelope Consultant (RBEC)
- Registered Roofing Consultants (RRCs)
- Registered Waterproofing Consultants (RWCs)
- Registered Exterior Wall Consultant (REWCs)
- Registered Roof Observers (RROs)
- Certified Exterior Insulation and Finish System (EIFS) inspectors
- Curtain Wall Specialists
- ICC Certified Building Inspectors
- Quality Assurance Monitors
- Water Testing Experts
- Leak Investigation and Diagnosis Experts
- Infrared Imaging and Nuclear Moisture Scanning Experts



ABBAE Building Expertise

- Building Envelope Systems
 - Roofing Systems
 - High-Slope/Low-Slope Roofs
 - Green/Garden Roofs
 - Drainage Systems
 - Pedestrian Plazas
 - Exterior Wall Systems
 - Wall Cladding
/Siding/GFRC/pre-cast
 - EIFS/cement plaster/stucco
 - Sheet Metal Flashings
 - Windows and Glazing Systems
 - Punched Windows
 - Curtain Wall/Window Wall Systems
 - Sliding Glass Doors
 - Skylights
- Building Envelope Systems (cont'd)
 - Roofing & Waterproofing Systems
 - Deck/Balcony/Lanai Waterproofing
 - Podium Waterproofing
 - Pool/Spa Deck Waterproofing
 - Above-Grade/Below-Grade Waterproofing
 - All types of low and steep sloped roofing
 - Commissioning BECx
 - OPR/BOD/Commissioning Plan
 - Mechanical/HVAC Systems
 - HVAC design
 - Plumbing systems
 - Commissioning and testing



ABBAAE Core Services

- Consulting and third-party peer review services
- Engineer of record for building envelope systems
- Contract administration services
- Inspection services (usually direct with owner)
- Air and water performance testing
- Mock-up design, observation, and testing
- Building assessments and forensic investigations
- Litigation support and expert witness services
- Educational seminars with AIA credits



Outline

- Proper energy conservation design in new construction
- Identify building areas for improvement
- ASHRAE 90.1 and CA Title 24
- Prescriptive vs performance methods
- Solar friendly roof design
- Case Study



Energy Conservation Design

- Approach the building as a dynamic system
- Understand all the tradeoffs to optimize:
 - First cost
 - Energy savings and Return on Investment
 - Material longevity
 - Code mandates
 - Design / aesthetics
- One-off approach will result in higher first cost and higher operating costs...



Conservation Before Generation



Conservation
before
Generation

Master Plan
Conservation &
Generation



Energy Conservation & Solar – Driven by Code

- California Title 24 -2013, ASHRAE 90.1, etc
 - Lighting Changes
 - Lower Lighting Power Density, daylighting, dimming
 - Glazing
 - Increased glass and frame thermal barrier, orientation requirement
 - Walls
 - Higher R insulation, continuous insulation (U Value)
 - HVAC
 - Higher efficiency equipment, better control
 - Solar Ready Roofs (Title 24 Only)



ASHRAE 90.1

- Provides minimum standards for energy efficient design of buildings
- Reflects Code Requirement in some states – Nevada, Florida
- Define Design and Performance Standards for building assemblies and equipment
- Increased Energy Efficiency



1980 – 2015 ASHRAE Efficiency Guidelines Increased 59%



Source: US Green Building Council

Copyright 2020 Allana Buick & Bers, Inc.

Energy Code in CA - Title 24

- Design and Performance Code for California
- Similarities between ASHRAE 90.1 code updates and Title 24
- More efficient Building Envelope, continuous insulation



Title 24 Increase in Efficiency

- California Energy Code (CEC) – First Adopted 1977
- CEC ahead of Rest of the Country in Performance
- Trend Setter in Energy Efficiency

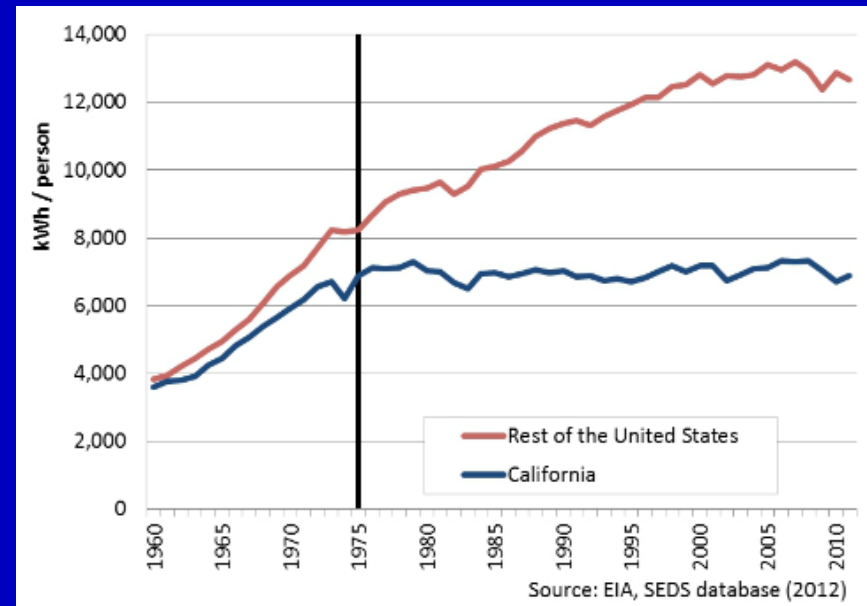

ASHRAE Compliance Paths

- Mandatory Measures
- Prescriptive Path
 - Complex flowchart and checklist path
 - Each category has to qualify on its own
- Performance Path
 - Beat the total energy budget for a building
 - Trade-offs allowed
 - Renewable energy provides strategic advantage



Prescriptive vs. Performance Compliance

Prescriptive

- Simpler
- Meet a prescribed min efficiency
- Little design flexibility
- Easy to use

Performance

- More complicated
- Offers considerable design flexibility
- Requires an approved computer software program
 - Models a proposed building (Like EnergyPro)
 - Determines its allowed Energy Cost Budget (ECB)
 - Calculated its energy use
 - And determines compliance



Mandatory Measures

- Both prescriptive or performance compliance paths require mandatory measures that must always be installed.
- Examples of Mandatory Measures:
 - Air leakage and Infiltration control
 - HVAC equipment efficiencies
 - Lighting and HVAC controls
 - Minimum insulation levels
 - Roofs
 - Walls
 - Heated slabs
 - Foundation perimeter
 - Fenestration



Performance Approach – Energy Cost

- In addition to mandatory requirements
- Baseline is established using energy simulation for a similar building of same size which is constructed as per ASHRAE 90.1
- Each category or the entire building has to come below the ECB Baseline to be acceptable – Possible combinations

- Envelope-only compliance
- Envelope and lighting compliance
- Envelope and mechanical compliance
- Envelope, lighting and mechanical compliance



CEC vs. ASHRAE

- CEC (Title 24) leads the national energy code ASHRAE 90.1
- CEC establishes the standard, 2 years later ASHRAE 90.1 leap frogs
- Site Energy Usage Intensity (EUI) comparison
 - Title 24 2005 – 250 kbtu/sq. ft.
 - ASHRAE 90.1 2007 – 243 kbtu/sq. ft.
 - Title 24 2008 – 210 kbtu/sq. ft.
 - ASHRAE 90.1 2010 – 198 kbtu/sq. ft.



Title 24 vs. ASHRAE 90.1

- New Construction Building (>100,000 sq. ft.)
 - ASHRAE 90.1 2010 = 1,407 Gbtu/yr*
 - Title 24 2013 = 1,250 Gbtu/yr*
 - Savings = 158 Gbtu/yr
 - 11% Better

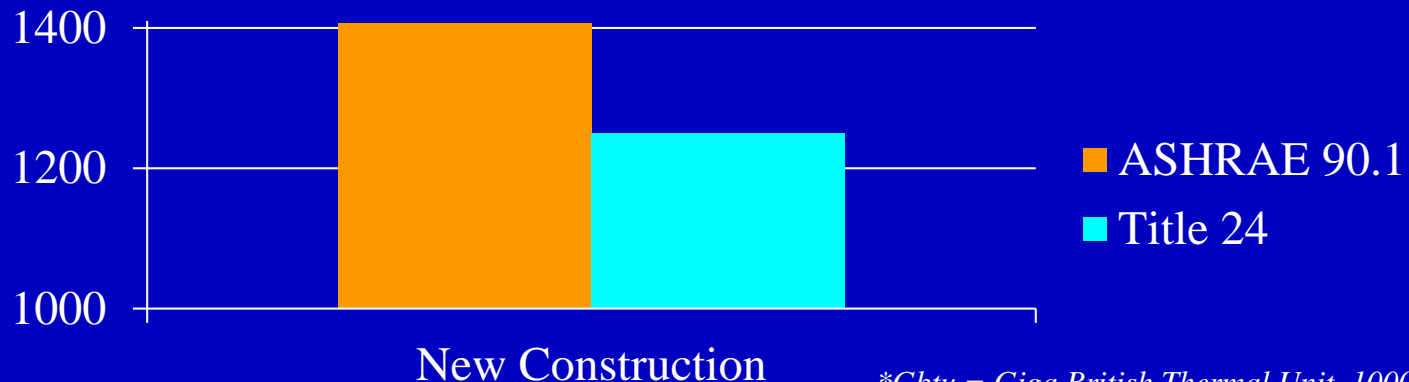

*Gbtu = Giga British Thermal Unit, 1000,000 kbtu



ASHRAE 90.1 and Energy Efficiency

- Building Envelope:
 - Wall Insulation Continuous (R Value vs. U Value)
 - Roof Insulation Continuous & Reflectance (R Value vs. U Value)
 - Glazing performance and Orientation (SHGC, VT)
- HVAC: Equipment Efficiencies and Control Strategies
- Lighting:
 - Lighting power density (LPD, expressed in Watts/Sq.Ft.),
 - Lighting controls,
- Domestic Hot Water: minimum equipment efficiency, minimum system features
- Renewable Energy Trade offs



R Value vs. U Value

- R Value
 - A measure of material's capability to resist heat transfer
 - Higher is better
 - Typically used for each material (layer)
- U Value
 - A measure of material or assembly's heat transfer efficiency
 - **Lower** is better
 - Typically used for the entire wall/roof/window assembly
- U value = $1/R$ Value



Building Envelope Walls

- Code has gotten smarter
- R value of each layer – is no longer what the assembly design is evaluated by
- U value of the total assembly is considered
- Code putting an end to thermal breaks



Code is Requiring Continuous Outside Insulation

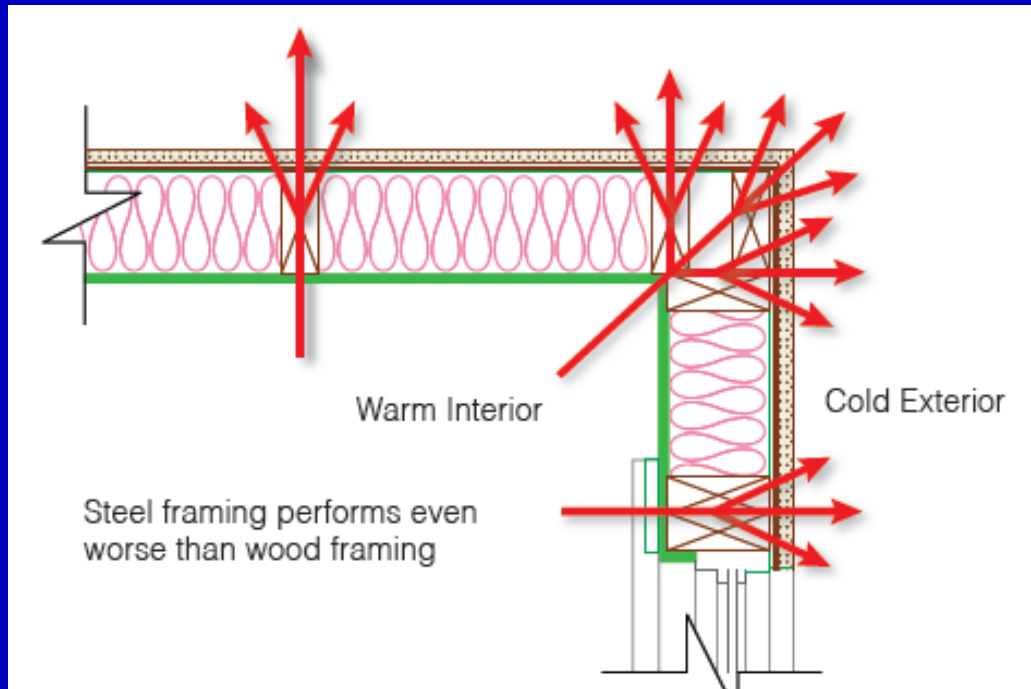

- Code Requires total minimum U Value
- No more individual R Value considerations



Typical Exterior Insulation

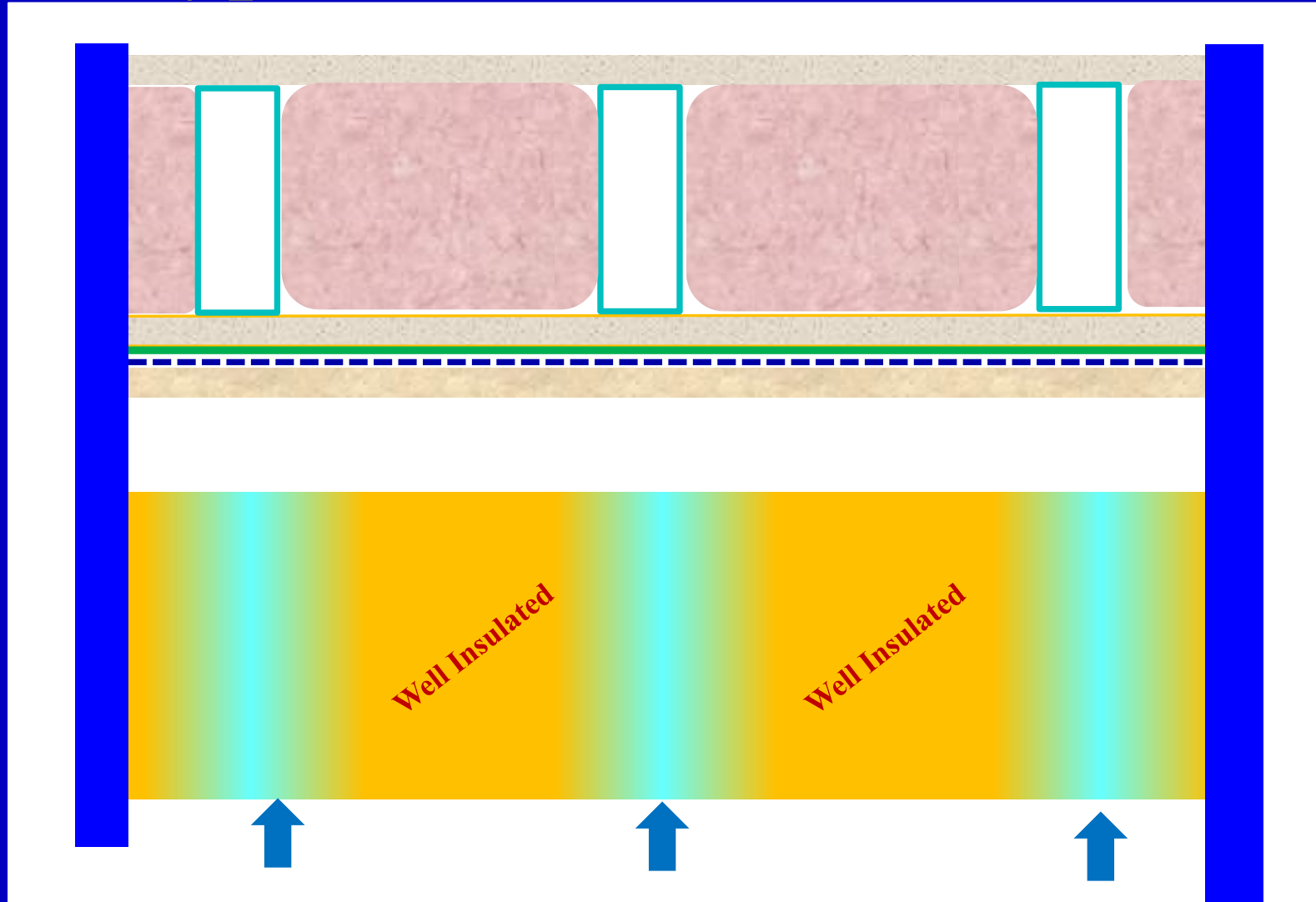

Thermal Anomalies

Typical Continuous Exterior Insulation

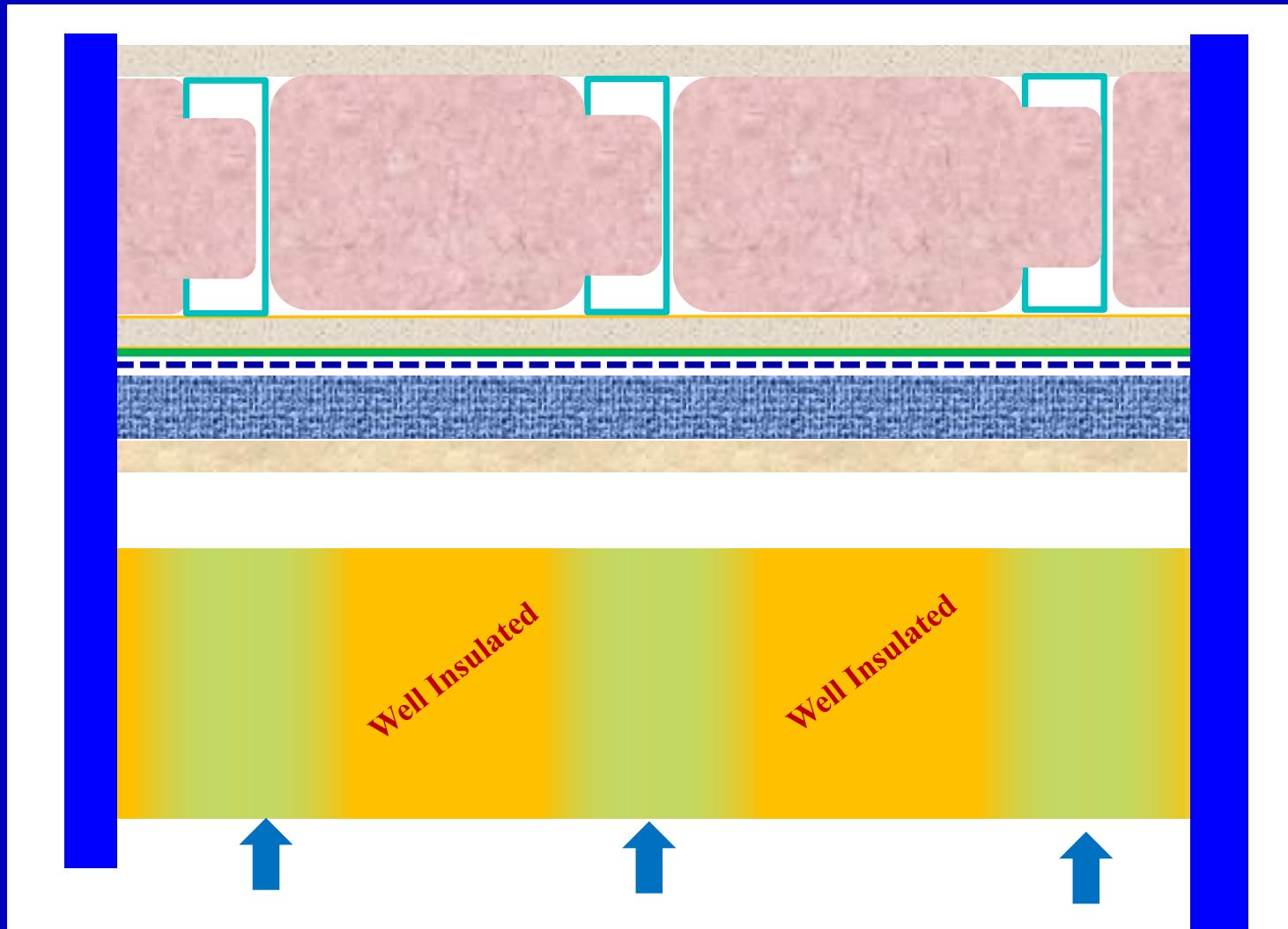

Smaller Thermal Anomalies



Real Numbers – Factoring in Thermal Bridging

- Insulation Installed R Value = R30
- Metal Framing with Concrete
- U Value of Assembly = 0.276
- Effective R Value = 3.6



ASHRAE U Value Requirements and CI

Opaque Elements	Nonresidential	
	Assembly Maximum	Insulation Min. R-Value
<i>Roofs</i>		
Insulation Entirely above Deck	U-0.039	R-25 c.i.
Metal Building ^a	U-0.041	R-10 + R-19 FC
Attic and Other	U-0.027	R-38
<i>Walls, above Grade</i>		
Mass	U-0.123	R-7.6 c.i.
Metal Building	U-0.094	R-0 + R-9.8 c.i.
Steel Framed	U-0.077	R-13 + R-5 c.i.
Wood Framed and Other	U-0.089	R-13
<i>Wall, below Grade</i>		
Below Grade Wall	C-1.140	NR



California is 350% to 400% More Restrictive

**TABLE 140.3-B
PRESCRIPTIVE ENVELOPE CRITERIA FOR NONRESIDENTIAL BUILDINGS (INCLUDING RELOCATABLE PUBLIC SCHOOL BUILDINGS WHERE
MANUFACTURER CERTIFIES USE ONLY IN SPECIFIC CLIMATE ZONE; NOT INCLUDING HIGH-RISE RESIDENTIAL BUILDINGS AND GUEST ROOMS OF HOTEL/MOTEL BUILDINGS)**

		CLIMATE ZONE																		
		1	2	3	4	5	6	7	8	9	10	11	12	13	14	15	16			
ENVELOPE	Maximum U-factor	Roofs/ Ceilings	Metal building	0.065	0.065	0.065	0.065	0.065	0.065	0.065	0.065	0.065	0.065	0.065	0.065	0.065	0.065	0.065	0.065	
			Wood framed and other	0.049	0.039	0.039	0.039	0.049	0.075	0.067	0.067	0.039	0.039	0.039	0.039	0.039	0.039	0.039	0.039	0.039
		Walls	Metal building	0.113	0.061	0.113	0.061	0.061	0.113	0.113	0.061	0.061	0.061	0.061	0.061	0.061	0.061	0.057	0.061	
			Metal-Framed	0.098	0.062	0.082	0.062	0.062	0.098	0.098	0.062	0.062	0.062	0.062	0.062	0.062	0.062	0.062	0.062	0.062
			Mass light ¹	0.196	0.170	0.278	0.227	0.440	0.440	0.440	0.440	0.440	0.170	0.170	0.170	0.170	0.170	0.170	0.170	0.170
			Mass heavy ¹	0.253	0.650	0.650	0.650	0.650	0.690	0.690	0.690	0.690	0.650	0.184	0.253	0.211	0.184	0.184	0.184	0.160
	Wood-Framed and other	0.102	0.059	0.110	0.059	0.102	0.110	0.110	0.102	0.059	0.059	0.059	0.059	0.059	0.059	0.059	0.042	0.059		
	Floors/ Soffits	Mass	0.092	0.092	0.269	0.269	0.269	0.269	0.269	0.269	0.269	0.269	0.092	0.092	0.092	0.092	0.092	0.092	0.058	
		Other	0.048	0.039	0.071	0.071	0.071	0.071	0.071	0.071	0.071	0.071	0.039	0.071	0.071	0.039	0.039	0.039	0.039	
	Roofing Products	Low- sloped	Aged solar reflectance	0.63	0.63	0.63	0.63	0.63	0.63	0.63	0.63	0.63	0.63	0.63	0.63	0.63	0.63	0.63	0.63	
			Thermal emittance	0.75	0.75	0.75	0.75	0.75	0.75	0.75	0.75	0.75	0.75	0.75	0.75	0.75	0.75	0.75	0.75	
		Steep- sloped	Aged solar reflectance	0.20	0.20	0.20	0.20	0.20	0.20	0.20	0.20	0.20	0.20	0.20	0.20	0.20	0.20	0.20	0.20	
			Thermal emittance	0.75	0.75	0.75	0.75	0.75	0.75	0.75	0.75	0.75	0.75	0.75	0.75	0.75	0.75	0.75	0.75	
Air Barrier			NR	NR	NR	NR	NR	NR	NR	NR	NR	REQ	REQ	REQ	REQ	REQ	REQ	REQ		
Exterior Doors, Maximum U-factor	Nonswinging	0.50	1.45	1.45	1.45	1.45	1.45	1.45	1.45	1.45	1.45	1.45	1.45	1.45	1.45	1.45	1.45	0.50		
	Swinging	0.70	0.70	0.70	0.70	0.70	0.70	0.70	0.70	0.70	0.70	0.70	0.70	0.70	0.70	0.70	0.70	0.70		

1. Light mass walls are walls with a heat capacity of at least 7.0 Btu/h-ft² and less than 15.0 Btu/h-ft². Heavy mass walls are walls with a heat capacity of at least 15.0 Btu/h-ft².

**Air Barrier Required
in some CZs**

1. CEC Steel framed building roof U= 0.062 vs ASHRE U = .22
2. CEC wood framed building wall U = 0.110 vs ASHRE U = 0.504
3. CEC is 350% to 400% more restrictive than ASHRE



Samples of Continuous Outside Insulation

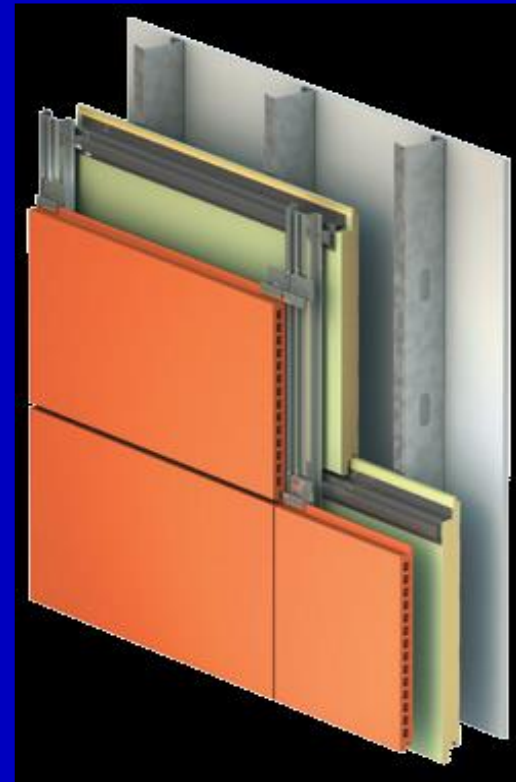
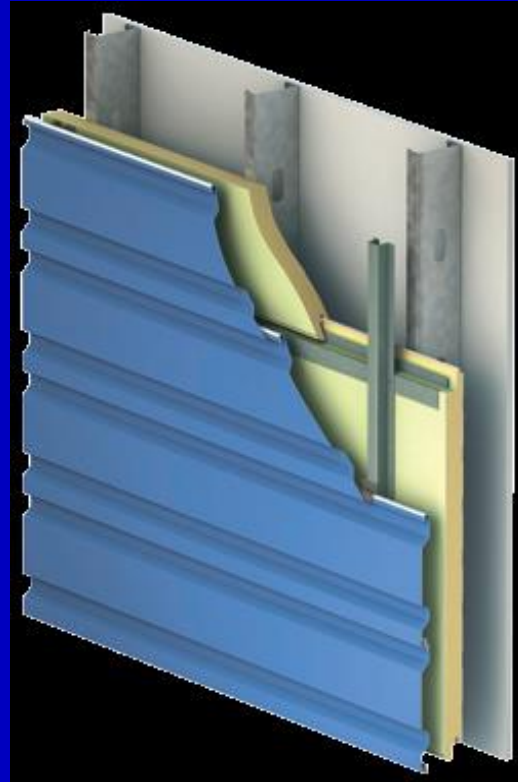
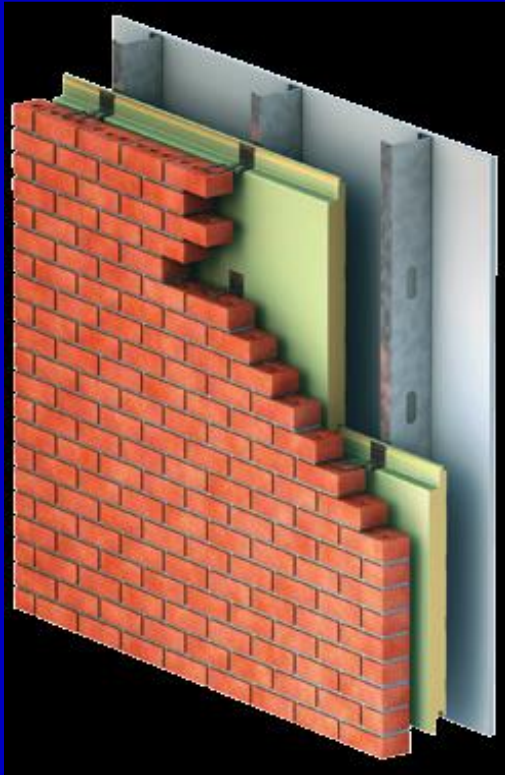

This system requires clips and mechanical fasteners that bridges heat.

Adhered EIFS does not require fasteners.



How do we solve the CI challenge?

- Material Selection



- Design Consideration

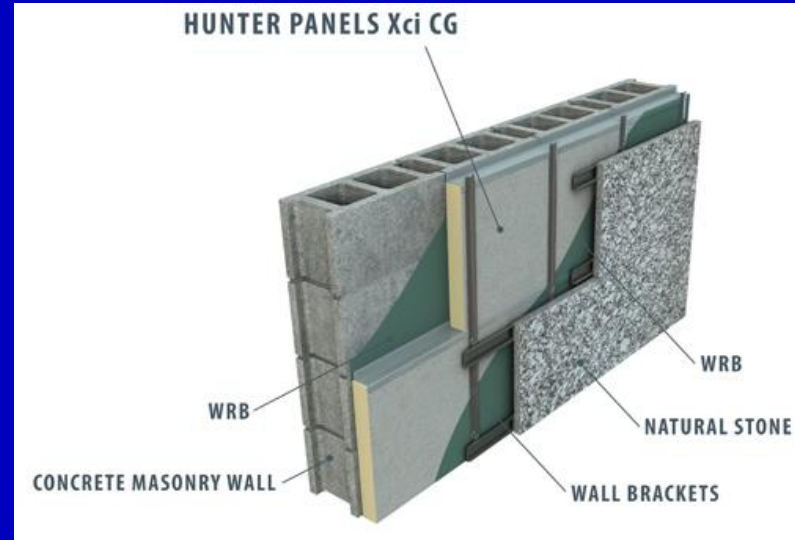

Building Envelope – Reflective Roofs

- Impacts HVAC
- Code requires high Emissivity Roofs
- New codes driving roof factor for higher reflectivity and lower emissivity

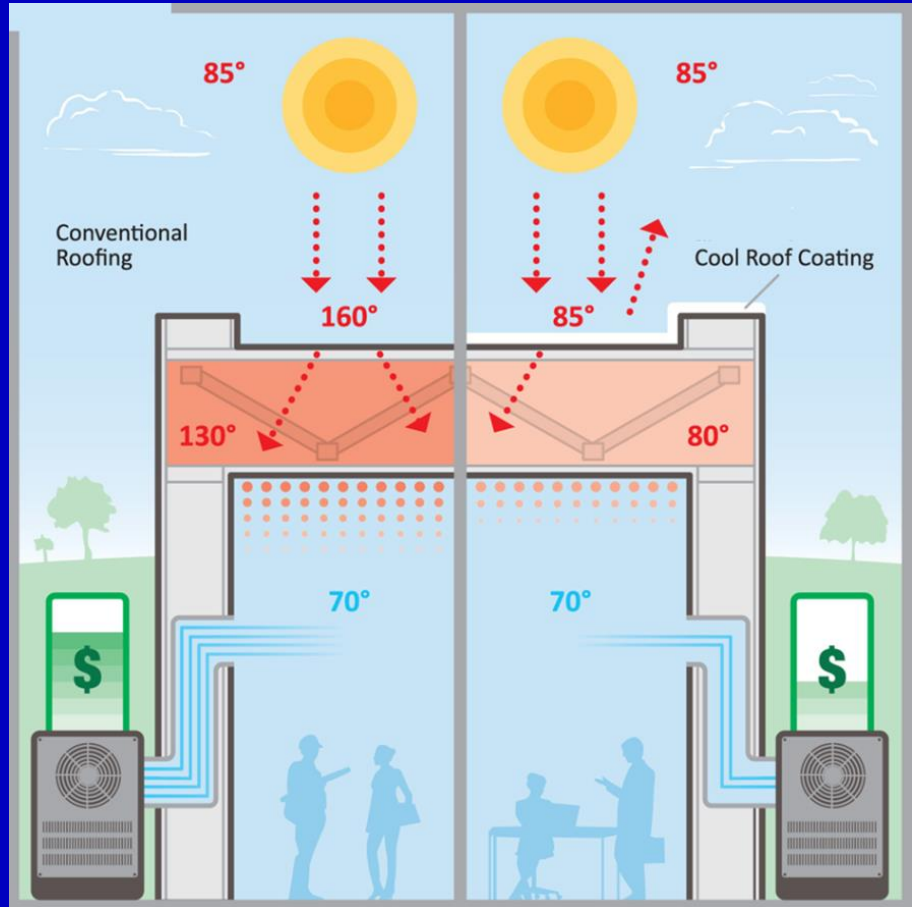

Solar Heat Gain Through Roof

- Solar reflectance:
Fraction of Heat Reflected
- Thermal emittance:
Fraction of heat transferred in

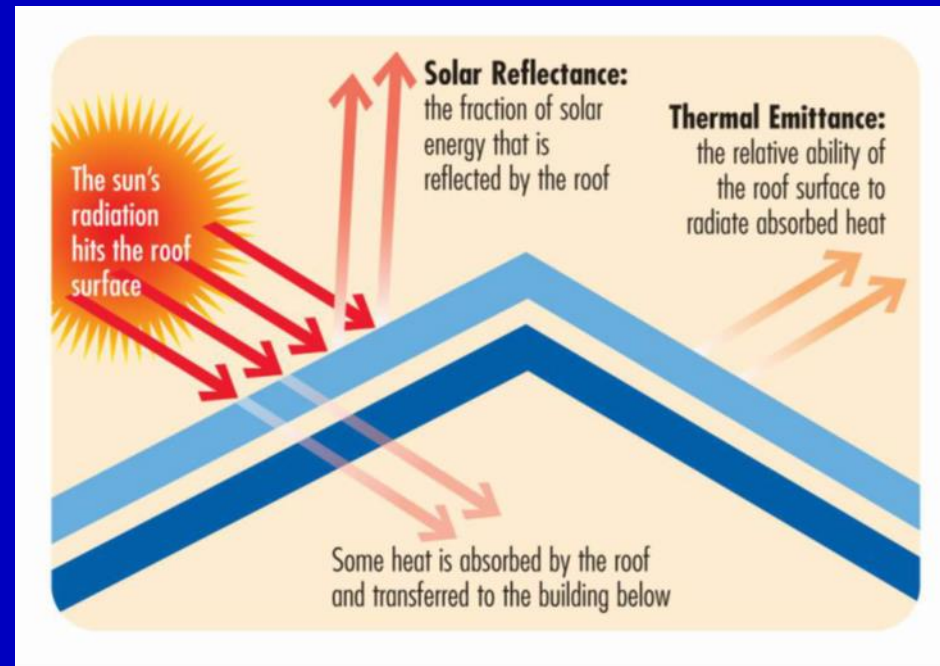

Prescriptive Requirements for Envelopes

- Increased low slope cool roof requirements.
- Higher Solar Reflectance from 0.55 to 0.63 for new and alterations
- Lower Thermal Emittance (TE)
- ASHRAE 90.1 2007, TE lowered from 0.9 to 0.75
- Same as CEC



Glazing ASHRAE 90.1 2013

- Low Solar Heat Gain Coefficient (SHGC)
- Higher Visual Transmittance (VT)
- Overall U value of assembly (as opposed to low e)
- Orientation Requirements East- and west-oriented glazing must each be less than 25% of the total glazing



Increased Fenestration Requirements

- Reduce solar gains and increase visual light transmittance for daylighting.
- Typical values for Curtain wall Assembly
- CEC Example Climate Zone 3 – California

Metal Framed Operable Fenestration	ASHRAE	CEC
U - Factor	0.60	0.36
SHGC	0.25	0.25
VT	0.275	0.42
VT/SHGC	1.10	1.68



Glazing Windows Heat Flow

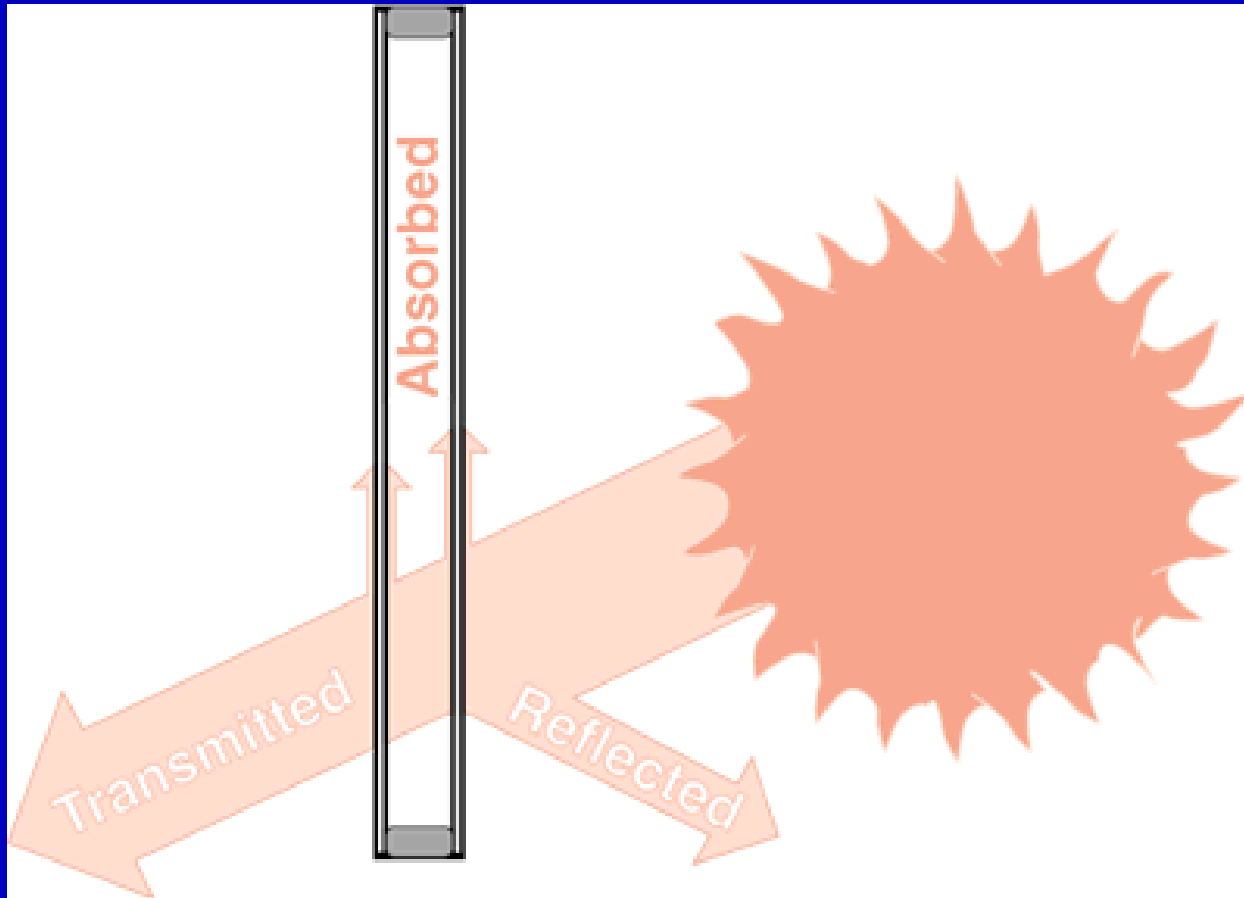

Windows – SGHC & VT

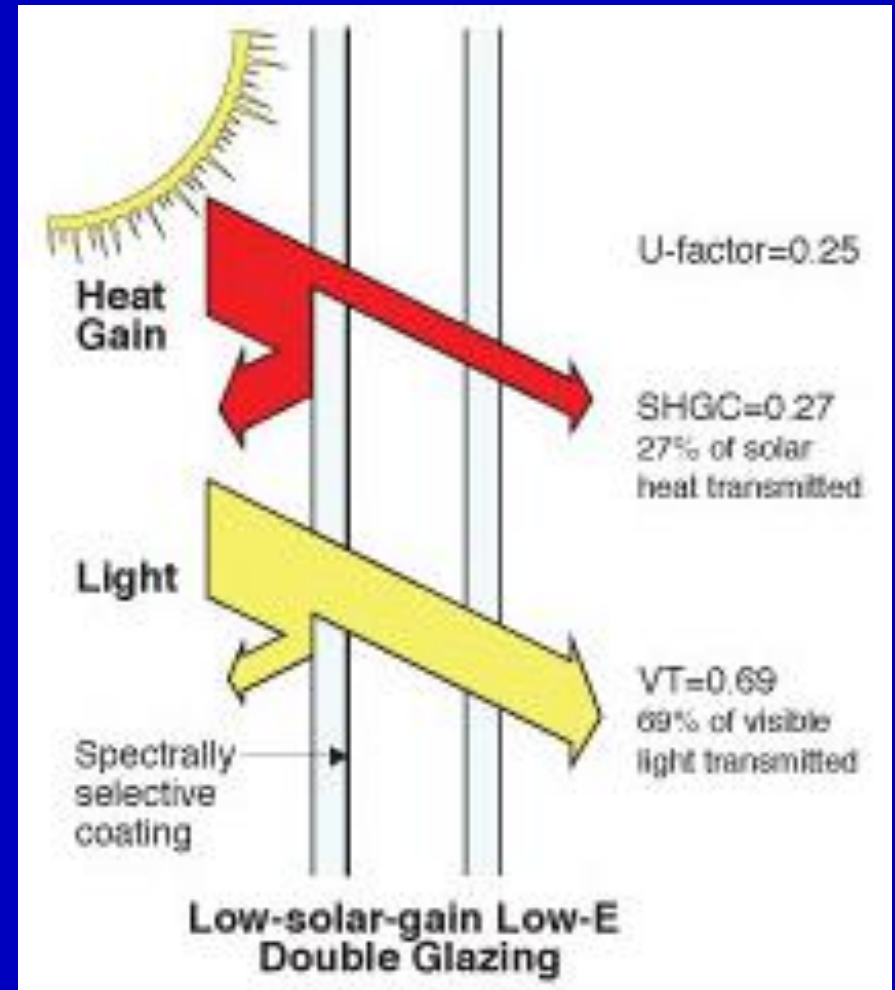
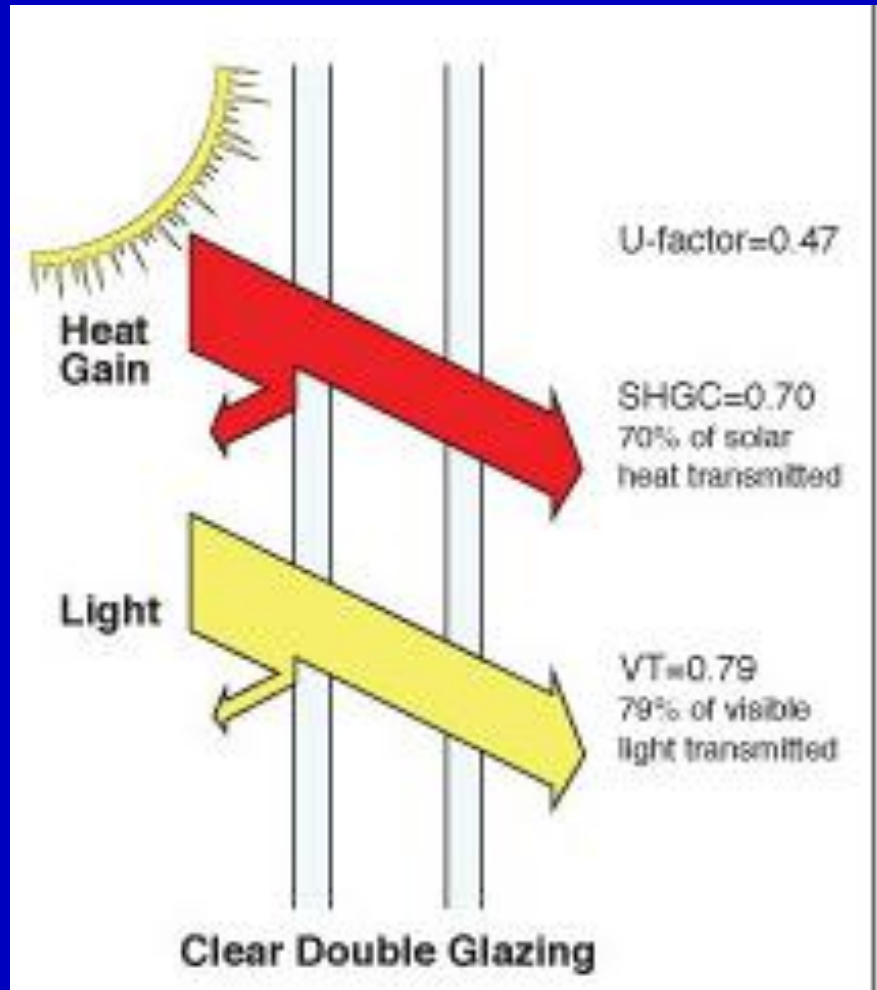

Pick The Right Glazing

Code now requires lower

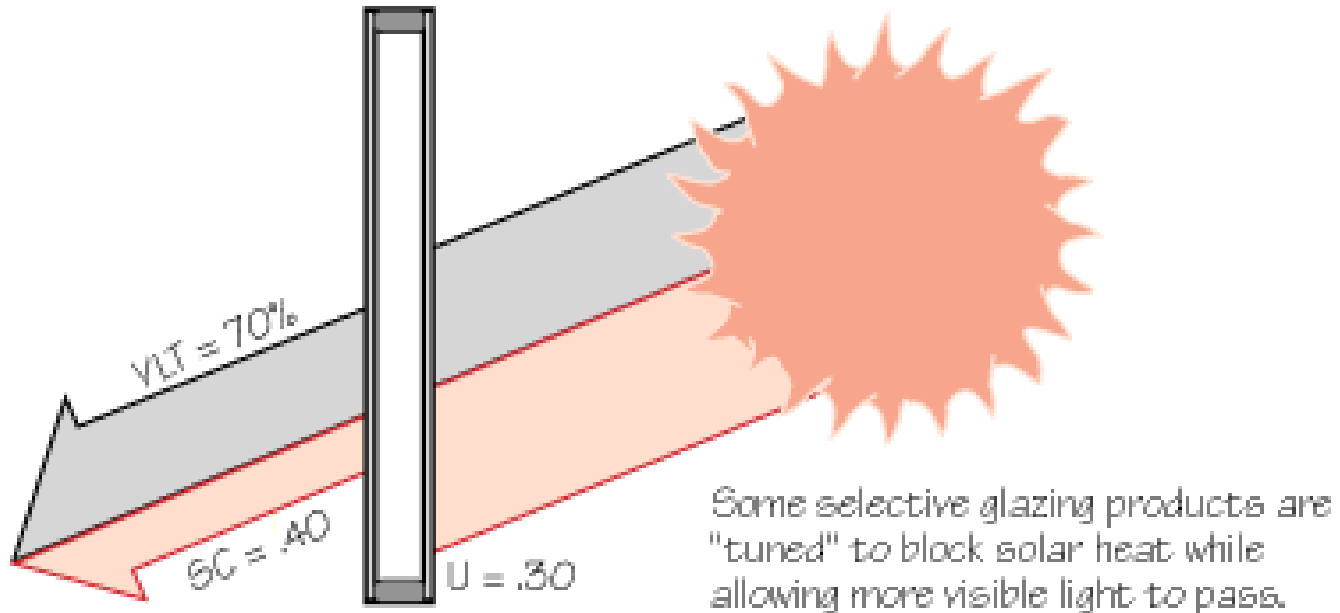

ASHRAE 90.1 and Daylighting

- Requires minimum Skylight for spaces below ceiling
- Restricts maximum Skylighting to 3% of Roof Area
- Limits vertical fenestration to 40% of the total vertical area



Lighting Saving from Skylights Are Offset by Cooling and heating costs. 2-4% of roof area is optimum.

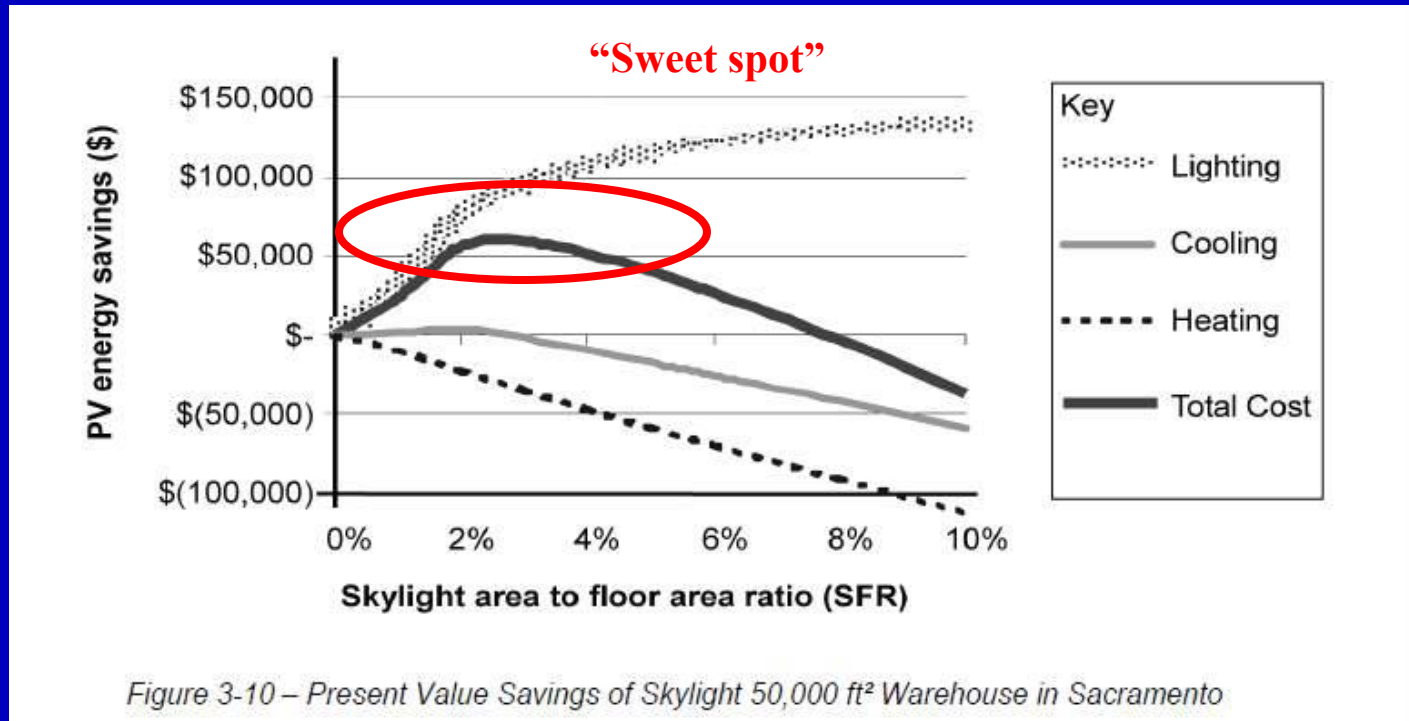

Building Systems - HVAC

- ASHRAE 90.1 2013 Requires
 - Higher Equipment Efficiencies
 - Direct Digital Controls (DDC)
 - Central Cooling and Heating Plants over 300 MBH
 - Zoned HVAC Systems
 - Multi Cell Cooling Towers
- Total 8.5% Reduction from 2010 code



Building Systems - Lighting

- Impacts HVAC
- One of the major energy consumers
- New Code requires
 - Lower Lighting Power Density (LPD)
 - *Its time for LED*
 - Automatic Controls
 - Limitations on exterior lighting
 - Better efficiency and efficacy



Lighting Energy Consumption

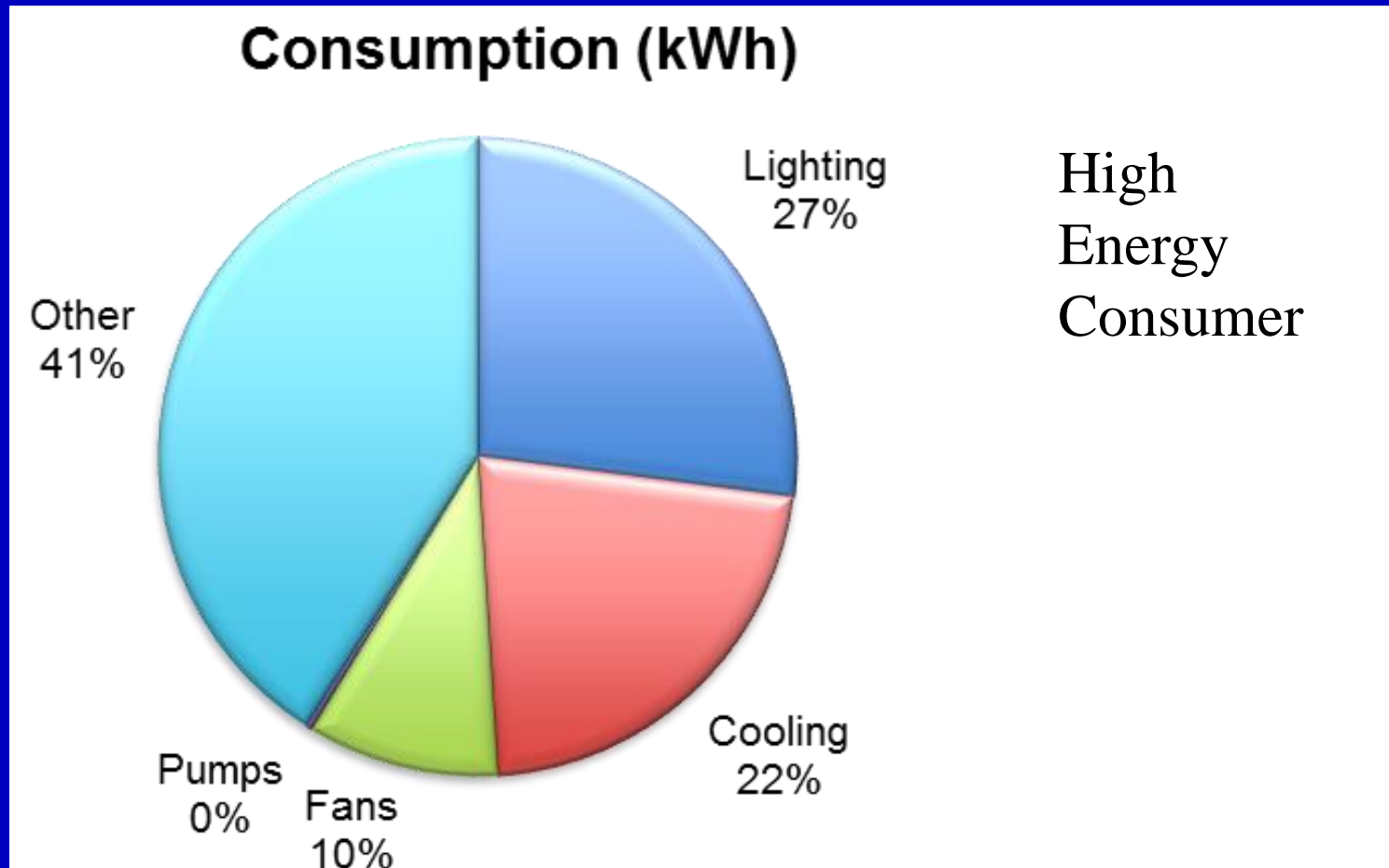

Lighting Types & Technology

- Incandescent

- Edison bulb
- Metal Halide
- HPS

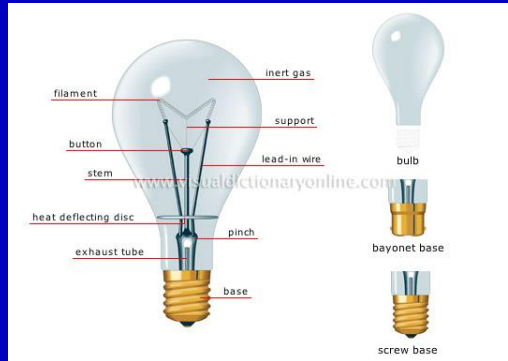

- Fluorescent

- T5,8,12 Tubes
- CFL

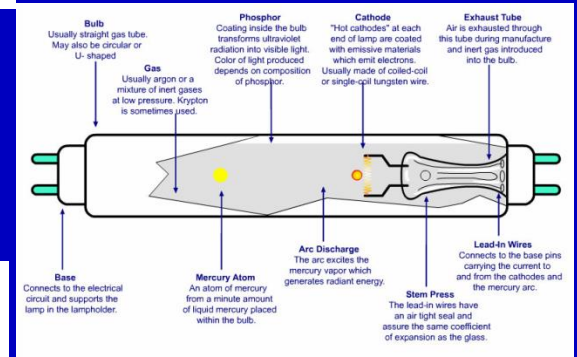

- LED

- Lamps
- Fixtures

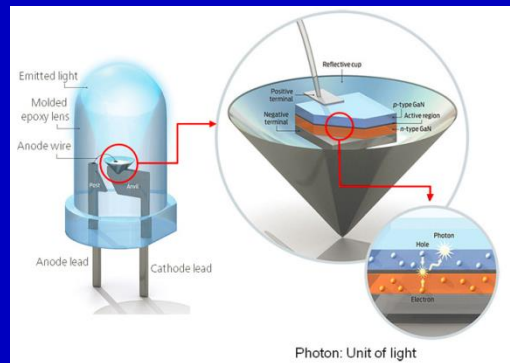

Lighting - Efficacy

- Lumens of Light per Watt of Energy Consumed
- Incandescent – 20 lm/W
- Fluorescent – 46 to 75 lm/W (230% to 375% Increase)
- LED – 87 to 100 lm/W (133% to 189% Increase)
 - Theoretical Limit of what is possible – 300 lm/W
 - Almost 60 times more efficient than incandescent
 - New Technology – No more blue glare



CA Leading Solar Ready Design

- Designated Solar Zones on roof
 - At least 10% of roof area
 - No shading in solar zones
- Orientation of Building
- Minimized Shading
- Structural Design
- Interconnection Pathways



Example – NOT Solar Friendly Roof

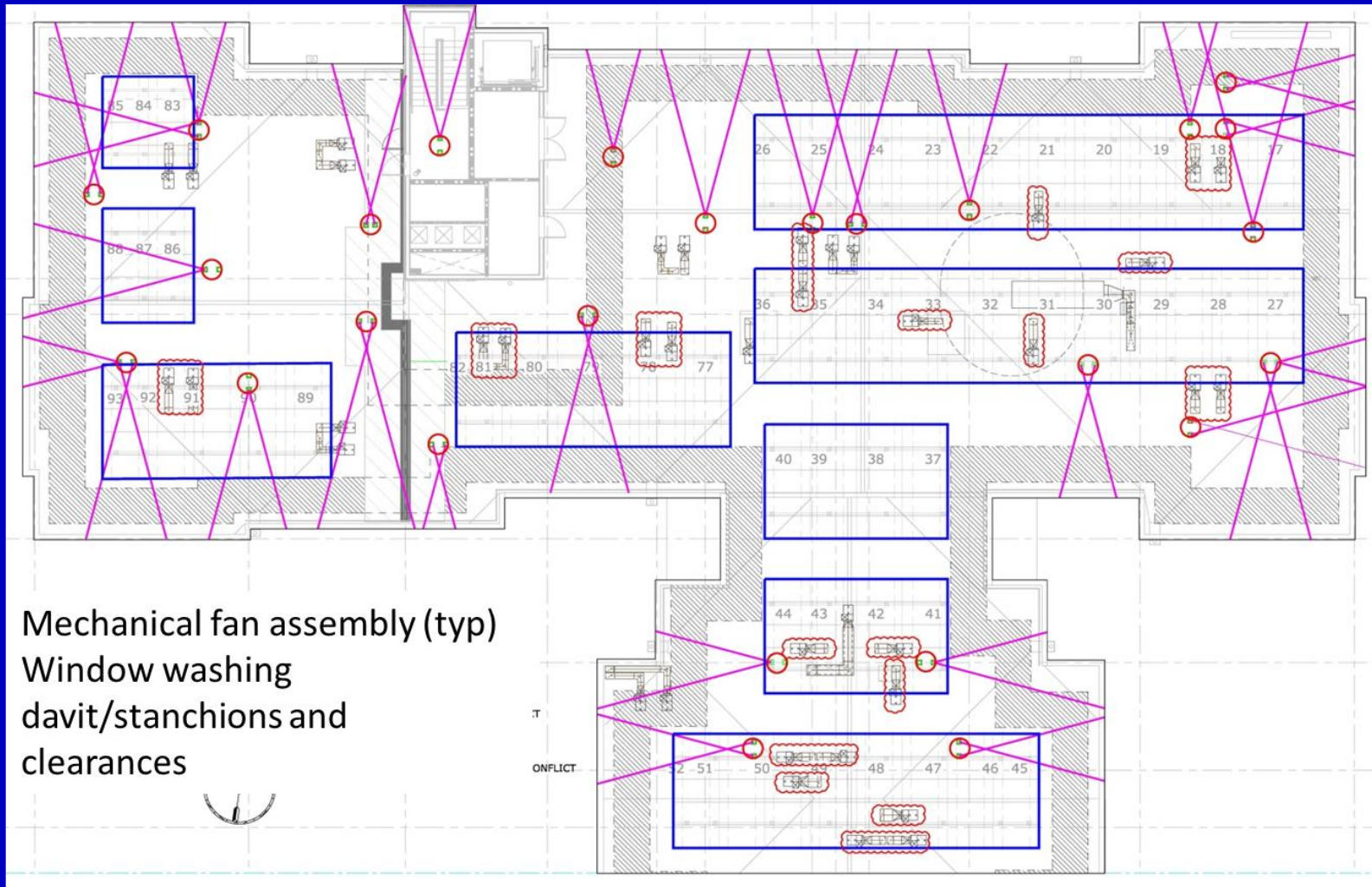

Performance Based Renewable Energy Trade offs

- Site-recovered & Site-generated energy credit allowed
 - Not considered “purchased energy”
 - Deducted from “proposed design” energy consumption via Energy Cost Budget Method
- Renewables
 - Solar Photovoltaic – Electric
 - Solar Thermal – Thermal



Case Study – Nevada Nursing Facility



Case Study

- 75,000 Sq. Ft. Skilled Nursing Facility
- Las Vegas, Nevada
- New construction on a 2.3 acre site
- Designed to ASHRAE 90.1 2007 Energy Standards
- LEED Silver objective



Case Study – General Construction



- Steel Frame Building
- Punched Windows – Aluminum Frame
- Fenestration – Glass store front and Punched windows



Case Study - Owner's Objectives

- Analyze potential energy efficiency improvements beyond ASHRAE 90.1 2007 baseline for CD's
- Identify package of Energy Conservation Measures (ECM)
 - 15 Year Payback Test
 - Prefer 2x Increase In Building Value
 - Marginal payback considered if other soft benefits



Theoretical Building Utility Baseline

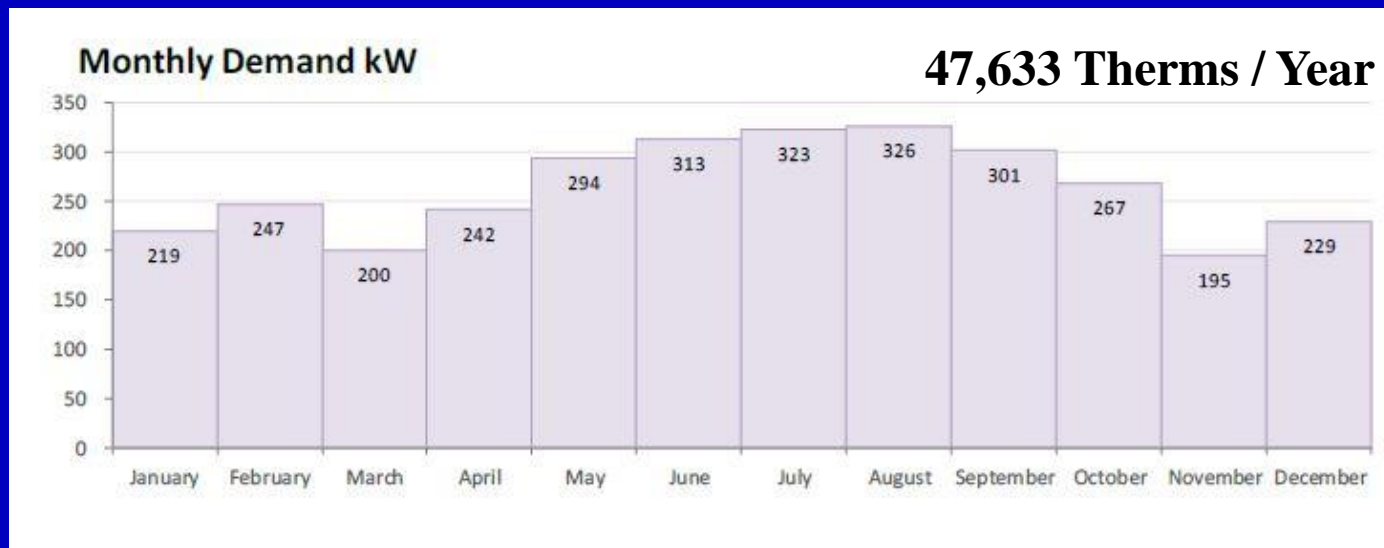

Baseline Consumption

- Desert climate with extreme hot & cold
- Electric Usage:
 - 27% Lighting
 - 32% HVAC
 - 41% Plug loads etc
- Gas Usage:
 - 77% Heating
 - 8% Hot Water

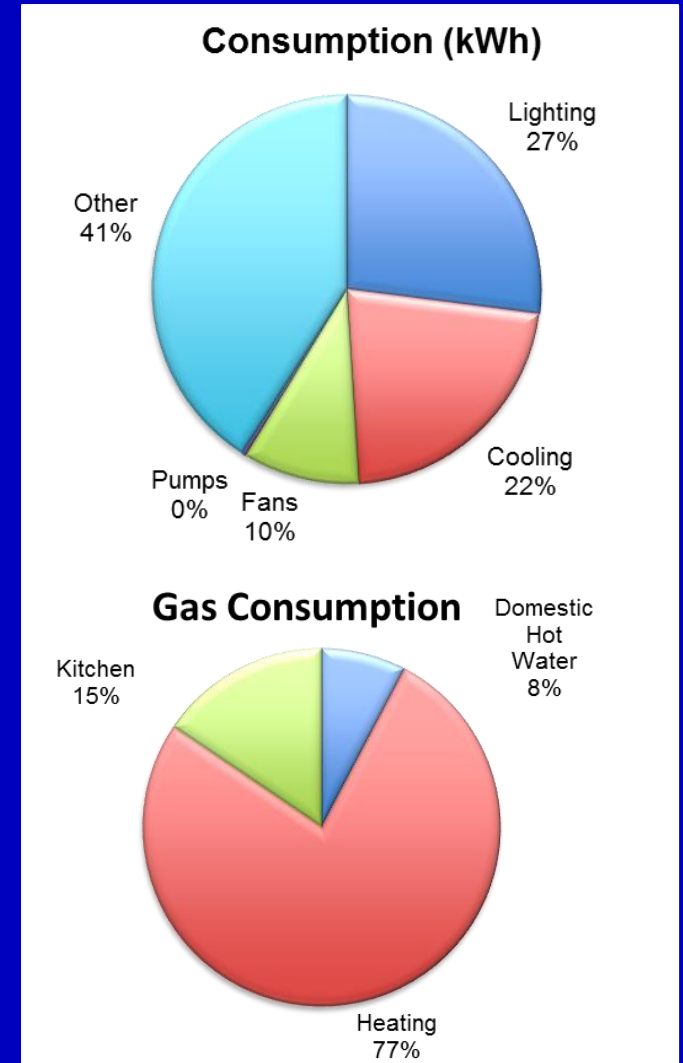

Baseline Energy Consumption

- First Year (estimated)
 - Total Utility Cost = \$ 128,000
 - Electric Utility Cost = \$ 117,000
 - Gas Utility Cost - \$ 11,000
- Lifetime Costs (30YR)
 - Approximately \$8,000,000



Case Study – Wall Assembly



- Wall Assembly
- Proposed Changes
- Changes to R and U value
- Financial Analysis



ECM - Walls

- Exterior Walls Design – R13
- Explored additional rigid insulation
- A consistent value for rigid insulation is R5 per inch
- Explored additional R5, R10, R15, R20
- Selected Additional R10 (total R23)
- Reduced Peak Solar Gain by 50%



Original vs. ECM – Wall

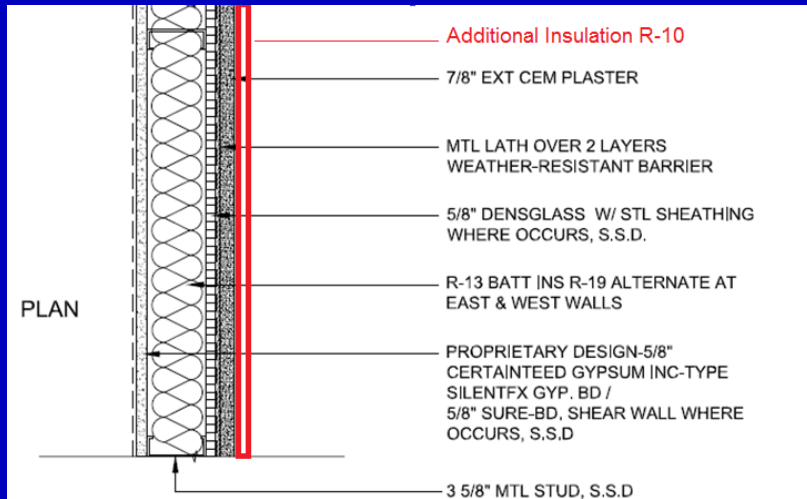

- Exterior Continuous 2 inch Insulation
- Metal Studs
- Thermal Breaks at Studs
- R Value = 13
- Old U Value = 0.217

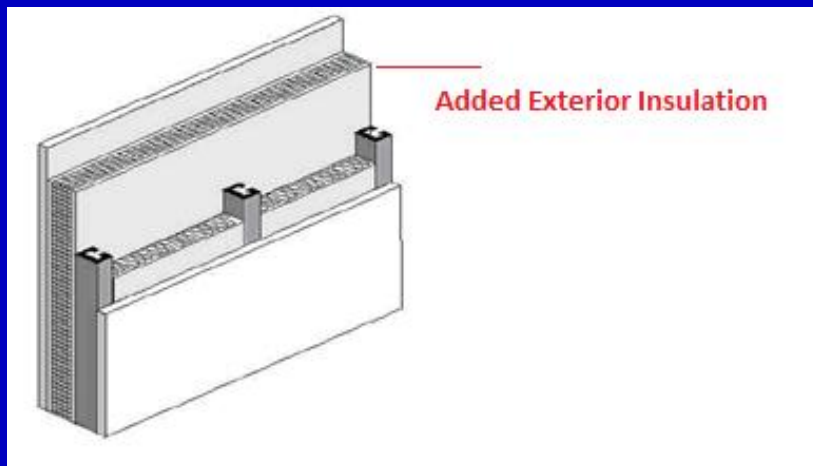

- Additional exterior insulation of R 10
- New U Value (assembly) = 0.068
- Lower the better
- Effective R Value = 14.6



Financial Analysis Results – With Continuous Exterior Wall R-10

- Pay Back: 19.1 Years
- Result: Fail
- Included in Final Design: No
- Key Financial Information:
 - Cost to install: \$95,000
 - Year 1 savings: \$2,046
 - ROI: 2.2%
 - Year 1 increase in property value: \$29,235
 - Year 10 increase in property value: \$45,353

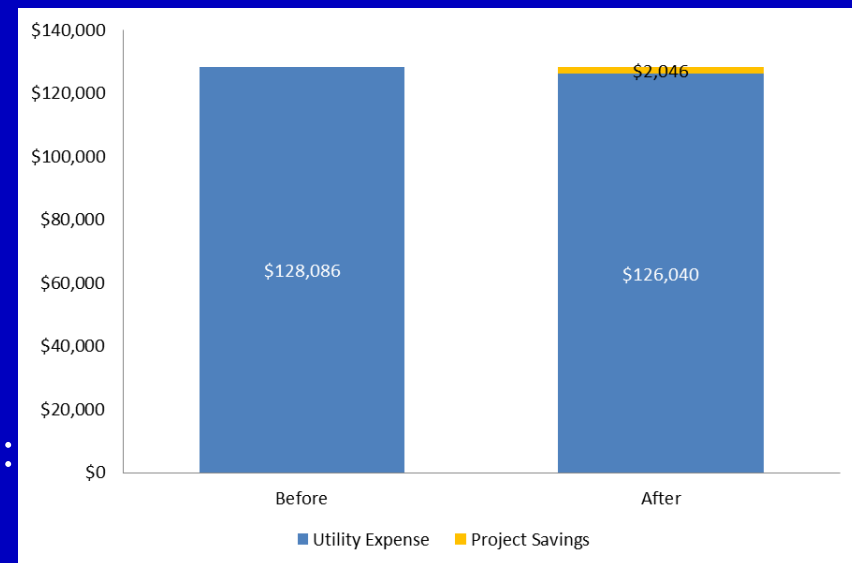

Case Study – Roof Assembly



- Reflective White Roof
- R30 Rigid Tapered insulation
- Moisture Barrier



Original Design - Roof

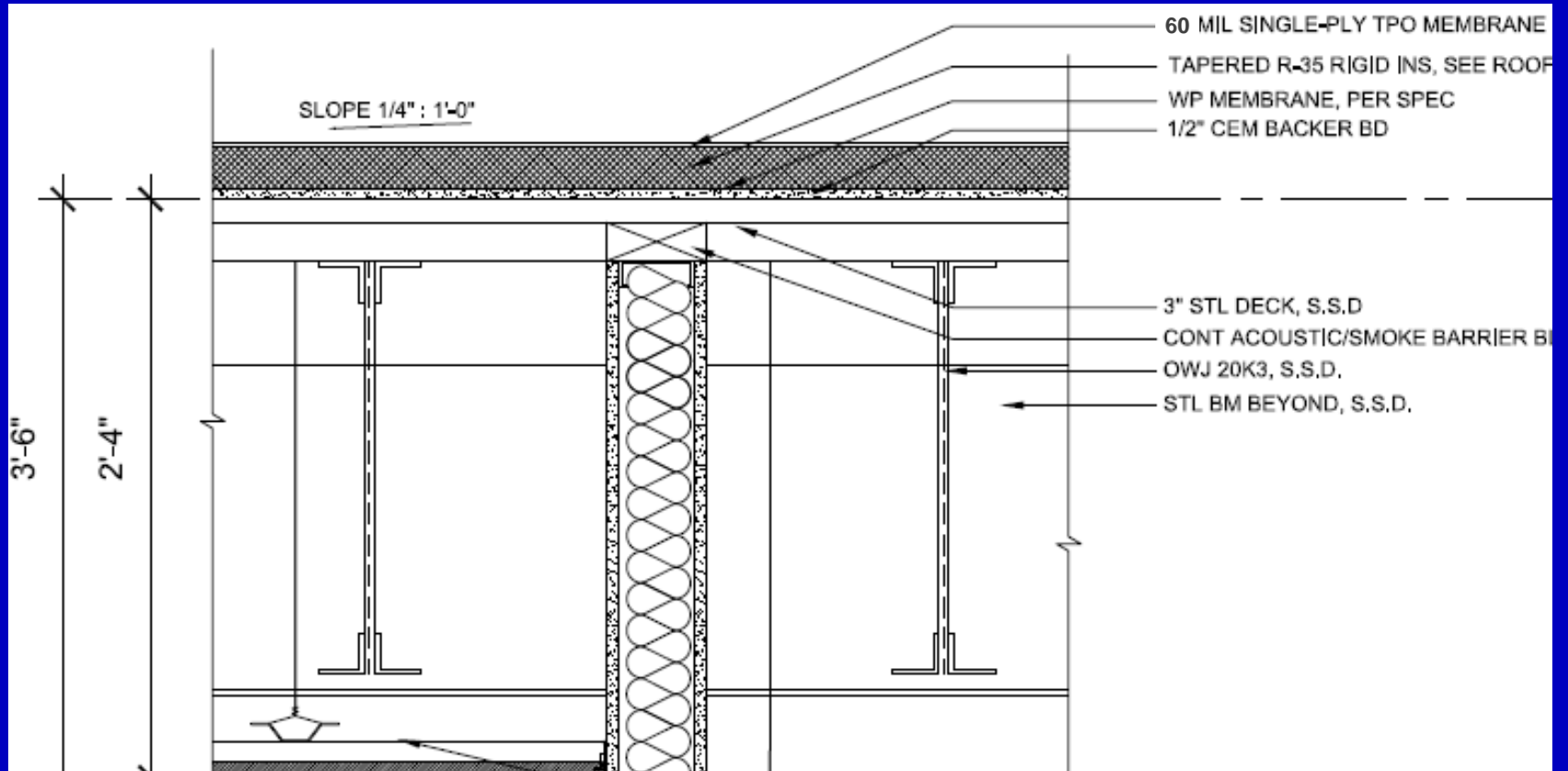

ECM – Roof Improvement

- Current Assembly U Value = 0.033
Explored additional R35, R40, R45, R50
- Installed Continuous Insulation – R35
- New U Value = 0.015
- Effective R Value = 38.6



Financial Analysis Results – Upgrade to Additional R-35

- Pay Back: Never
- Result: Fail
- Included in Final Design: No
- Key Financial Information:
 - Cost to install: \$147,000
 - Year 1 savings: \$1,200
 - ROI: 0.01%
 - Year 1 increase in property value: \$16,000
 - Year 10 increase in property value: \$26,000

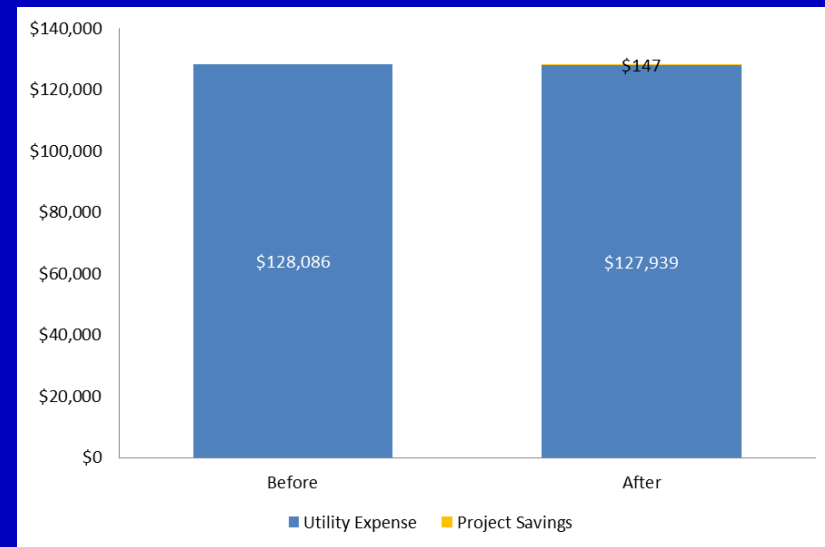

Increased Insulation Can Reduce HVAC Sizing

- Roof & Wall Insulation Only
- Cost: \$242,000
- Savings: \$3,220
- ROI: 1.3%
- Payback: 30+ YR
- Result: FAIL
- Reduction in HVAC tonnage: 25%
- Reduction in HVAC cost: -\$173,000
- Net Cost: \$69,000
- ROI: 4.7%
- Payback: 16 YR
- Result: Fail (Barely)
 - Perceived riskiness to downsize



Case Study – Glazing



- Current Window Glazing
- Proposed Glazing
- Financial Analysis



Original Design – Window Section

- Low E
- Solar Heat Gain Coefficient (SHGC) of 0.32

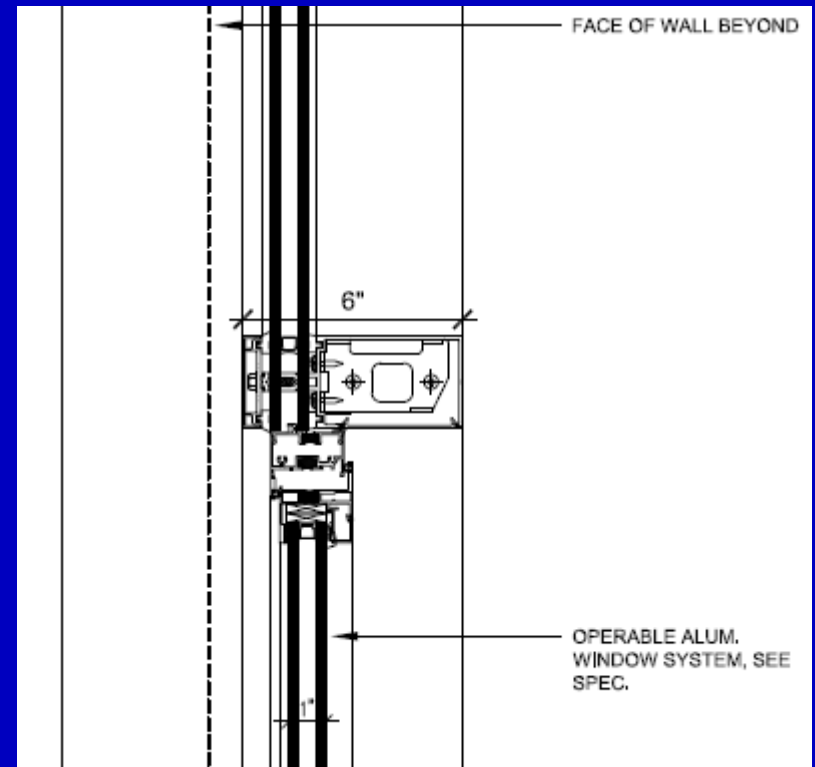

ECM - Windows

- Design Windows Glazing - SB60 and SB70XL series of glass (SGHC 0.4 and 0.32)
- Options Explored
 - SGHC 0.27, 0.24, 0.17
- Selected SGHC 0.24 Glazing
- Reduced Peak Heat Gain by 45%



ECM Window SGHC Change

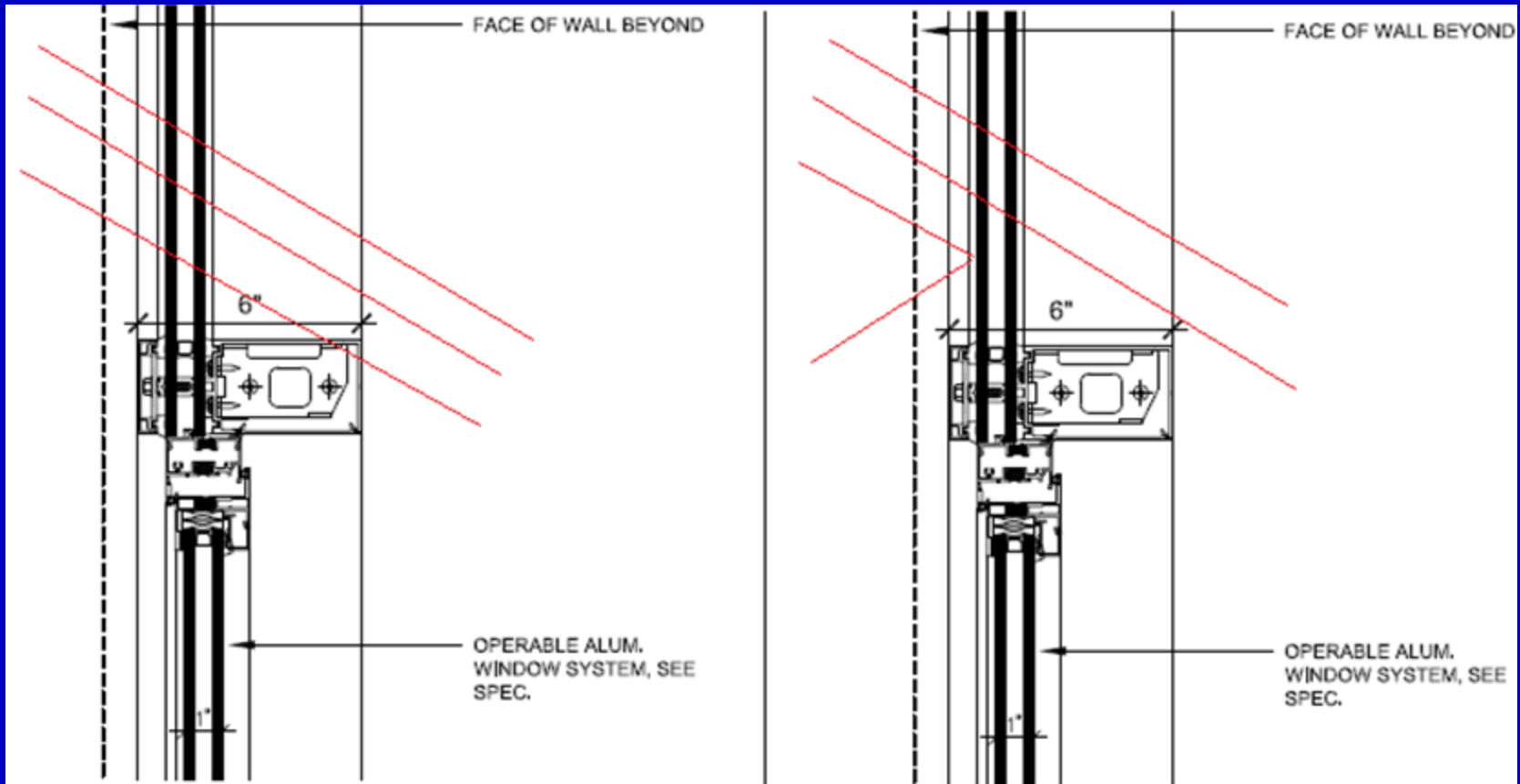

Baseline Design - SHGC - 0.32

New Improved Design - SHGC - 0.24



Financial Analysis Results – Windows

- Pay Back: 16.9
- Result: Fail
- Included in Final Design: No
- Key Financial Information:
 - Cost to install: \$30,000
 - Year 1 savings: \$762
 - ROI: 2.5%
 - Year 1 increase in property value: \$10,887
 - Year 10 increase in property value: \$16,890

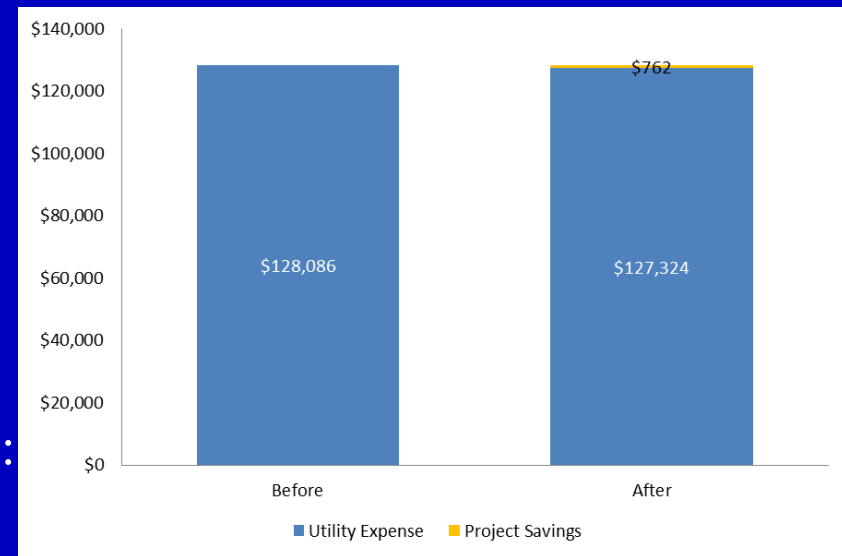

Case Study – Lighting



- Lighting Types
- LED vs. Other
- Benefits of Improved Lighting Design



Case Study Facility – Lighting

- Combination of T8 and Can CFL lights
- Limited controls of fixtures with occupancy sensors
- Simple daylighting controls with on/off photo-switches



Original Design Lighting Fixtures

T8 Lamp Fixture



CFL Cans



ECM - Lighting

- Original Design = Fluorescent and CFL
- Proposed design switch all fixtures to LED
- Lighting Control expanded to all fixtures
 - Photo-switches for exterior fixtures
 - Occupancy controls for office spaces with active dimming



Savings from Lighting Project

- 3 Types of Savings
 - Utility Savings
 - Maintenance Savings
 - HVAC Savings

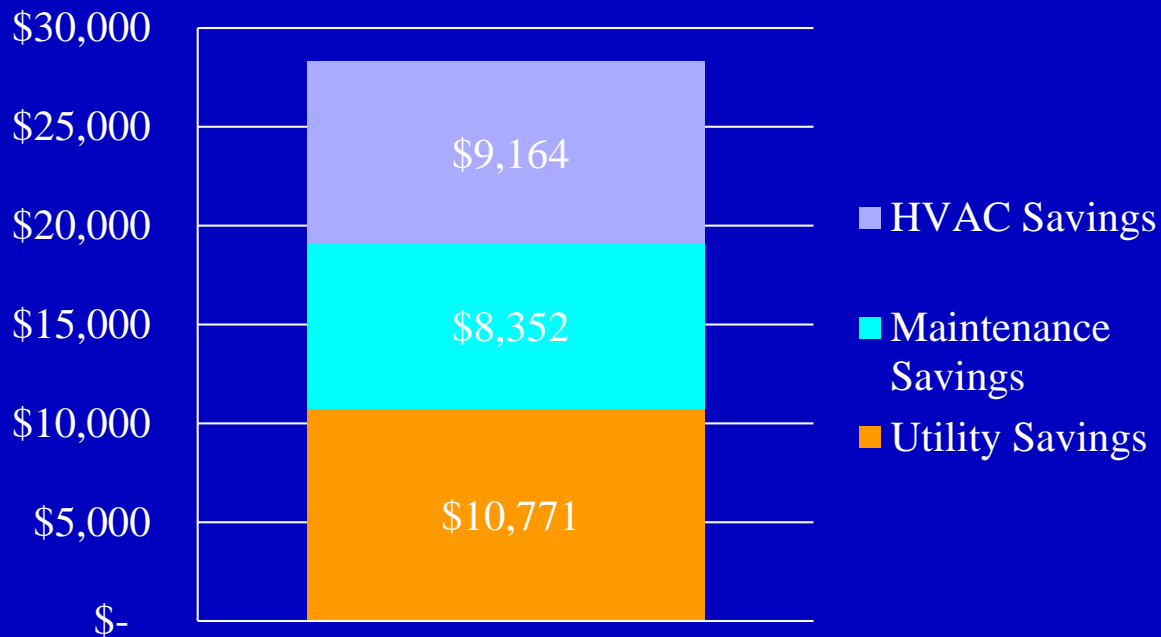

Year 1 Savings from Lighting



Proposed Fixtures - LED

Advanced Optics



No Blue Glare



Financial Analysis Results - Lighting

- Pay Back: 5.2 Years
- Result: Pass
- Included in Final Design: Yes
- Key Financial Information:
 - Cost to install: \$177,932
 - Year 1 savings: \$28,287
 - ROI: 15.9%
 - Year 1 increase in property value: \$404,000
 - Year 10 increase in property value: \$624,000

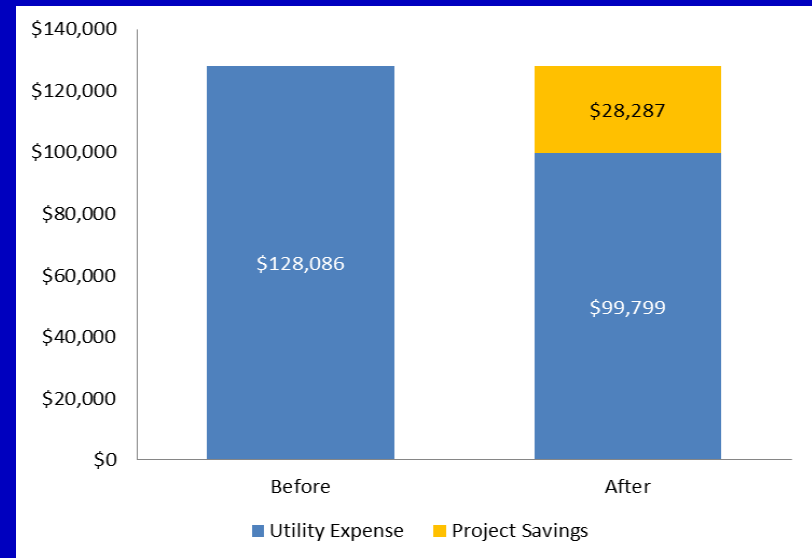

Case Study – HVAC



- Variable Flow Refrigerant System
- Duct Design Changes
- Financial Analysis



HVAC ECM Options

1. Change Primary Cooling From Split System to Mitsubishi Variable Refrigerant Flow (VRF) design
 - Split System (9.5 EER, 3.2 COP)
 - VRF System (15.7 EER, 8.5 COP)
2. Change Energy Recovery Ventilation design to reduce fan run time



ECM – HVAC VRF System Install

Variable Refrigerant Flow System

- Moves liquid refrigerant from central unit to each part of the building Very Efficient System
- Individually Controllable
- EER 15.7, COP 8.5

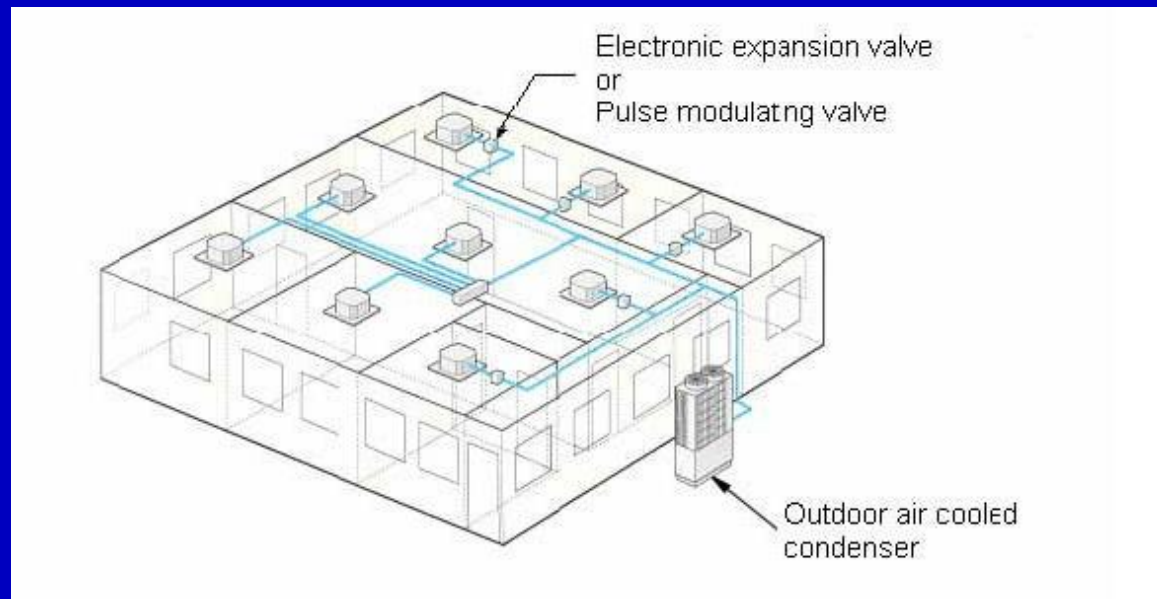

Financial Analysis Results – Upgrade to Mitsubishi VRF

- Pay Back: 14.8 Years
- Result: Pass
- Included in Final Design: Yes
- Key Financial Information:
 - Cost to install: \$989,000
 - Year 1 savings: \$36,406
 - ROI: 3.7%
 - Year 1 increase in property value: \$520,086
 - Year 10 increase in property value: \$758,922

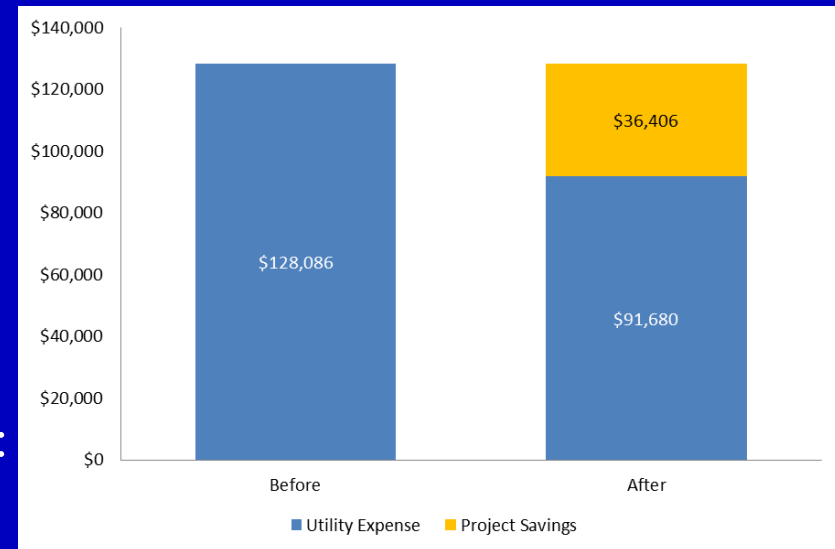

ECM – Change Ventilation Recovery Design

- Changed the duct design for energy recovery system to allow fans to run intermittently
- Upgraded HVAC Control Strategy using Energy Management Systems (EMS)
- Results
 - Fan Coil Units now operation intermittently
 - Fan operation energy savings



Financial Analysis Results – Change Ventilation Recovery

- Pay Back: 17.6 Years
- Result: Fail
- Included in Final Design: No
- Key Financial Information:
 - Cost to install: \$479,224
 - Year 1 savings: \$12,184
 - ROI: 2.5%
 - Year 1 increase in property value: \$174,000
 - Year 10 increase in property value: \$270,000

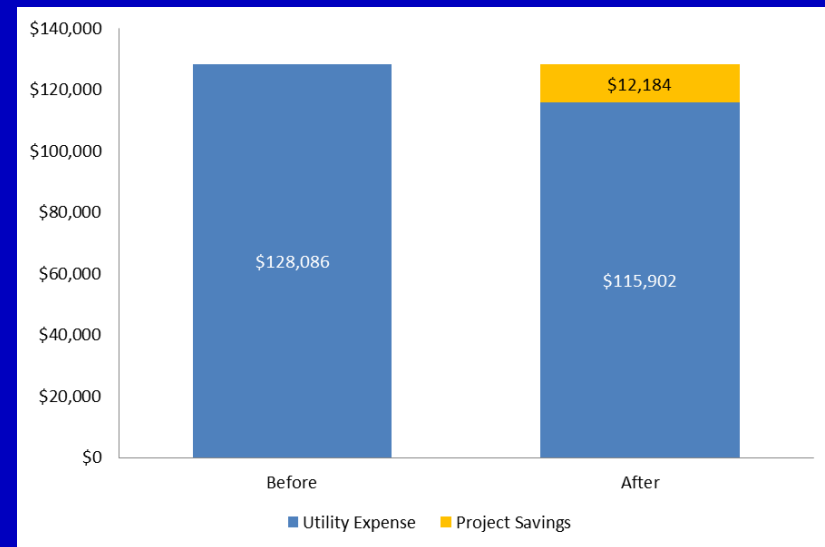

Case Study – Energy Generation Solar



- Understanding Location and Solar Irradiance
- Installed Solar PV and Solar Thermal
- System Details
- Financial Analysis



Nevada - Solar Irradiance

'Red' = Higher irradiance

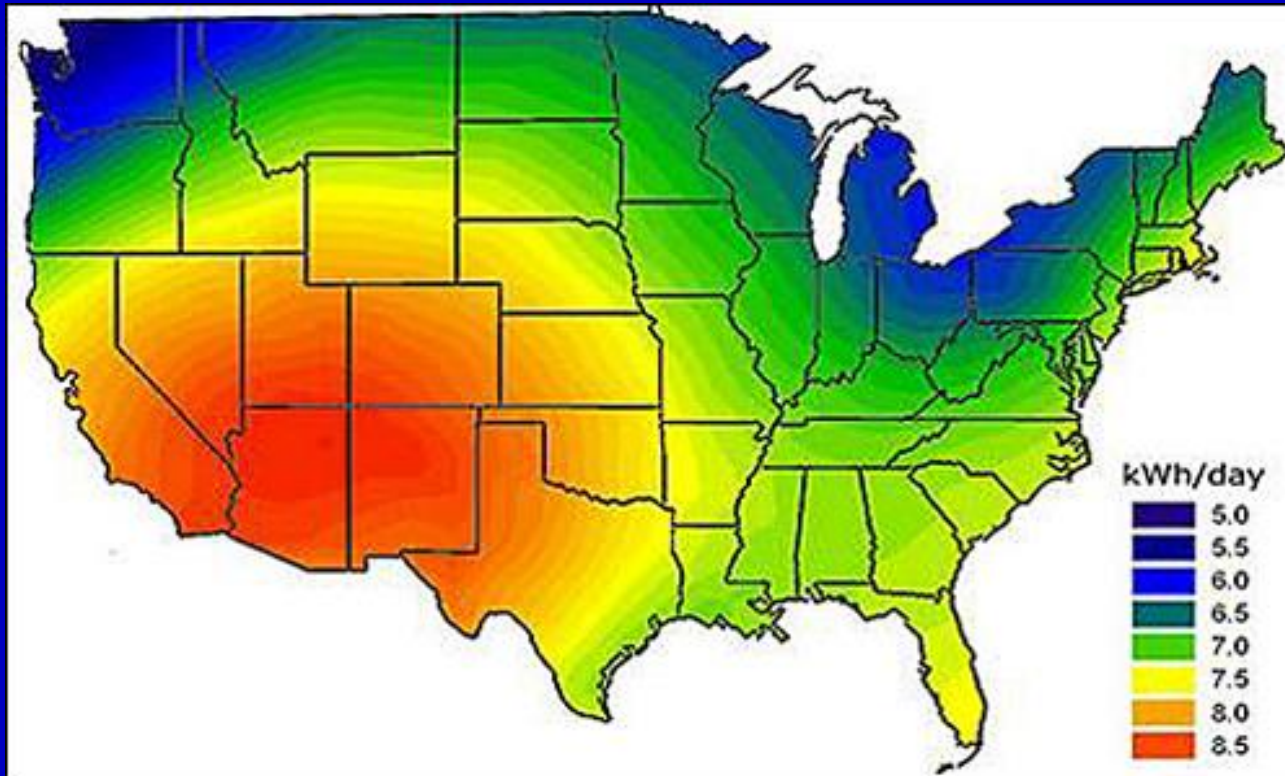

Energy Generation – Solar PV

- Proposed System Size
 - 205 kW DC
- Annual kWh Production – 338,112
- Installed on
 - Roofs
 - Carports



Financial Analysis – Solar PV

- Pay Back: 8.2 Years
- Result: Pass
- Included in Final Design: Yes
- Key Financial Information:
 - Cost to install after rebate: \$387,545
 - Year 1 savings: \$19,435
 - ROI: 5.0%
 - Year 1 increase in property value: \$236,000
 - Year 10 increase in property value: \$349,000



Energy Generation Solar Thermal

- Two types available
 - Evacuated Tube
 - Flat Plate
- Evacuated Tube used
- 35% Solar Fraction
- Annual Therm offset - 6956



Financial Analysis – Solar Thermal

- Pay Back: 13.8 Years
- Result: Pass
- Included in Final Design: Yes
- Key Financial Information:
 - Cost to install after rebate: \$118,785
 - Year 1 savings: \$4,566
 - ROI: 3.5%
 - Year 1 increase in property value: \$60,226
 - Year 10 increase in property value: \$74,989

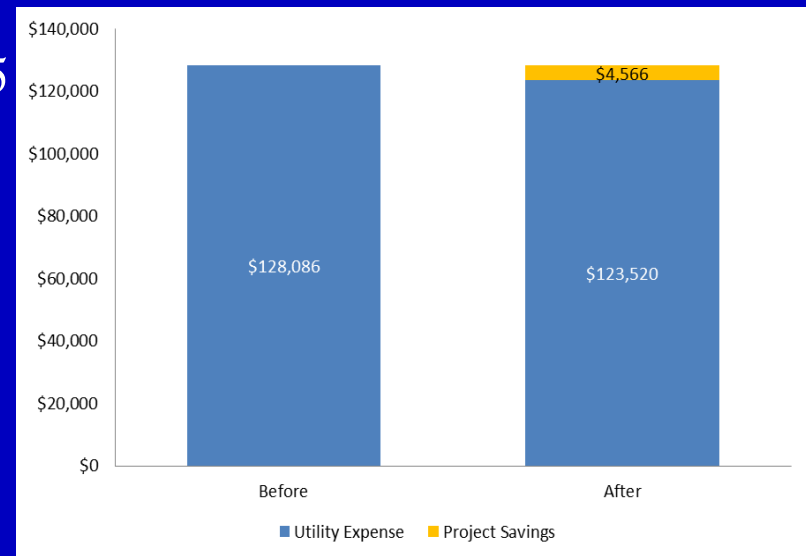

Case Study – Results of Improvements



- Improvement in Delivered Power Quality
- Financial Analysis



Electrical Consumption Reduction

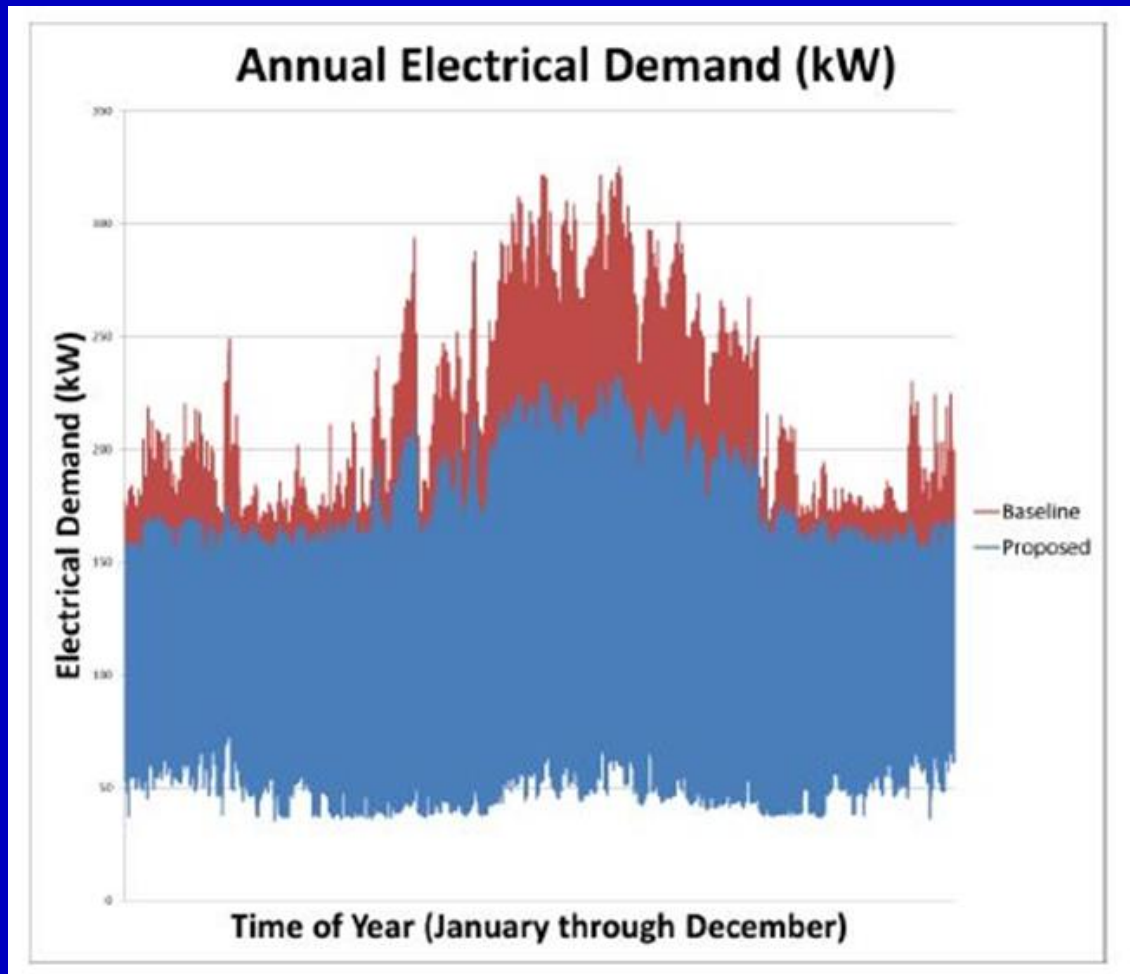

Gas Consumption Reduction

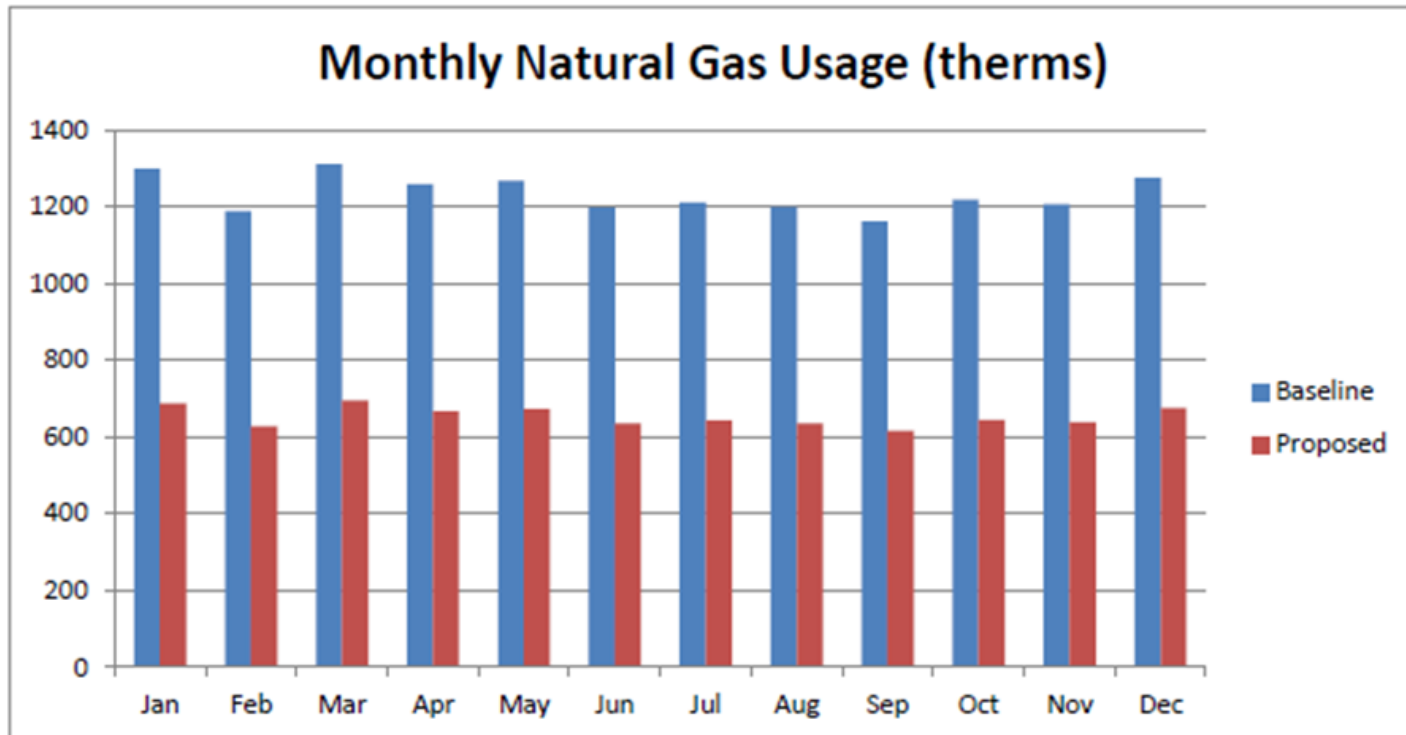

Summary of ECMs and Solar

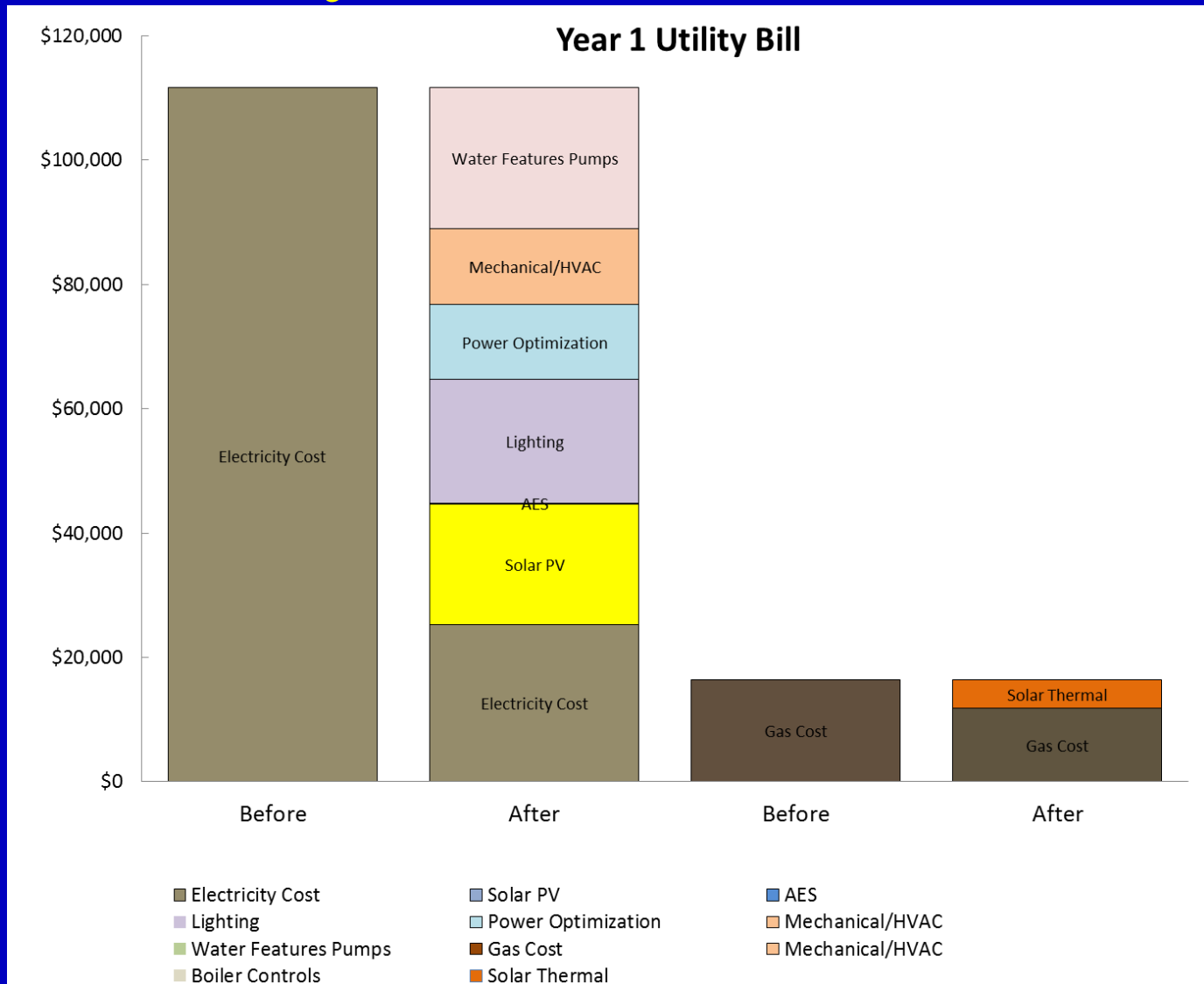

Summary of ECMs and Solar

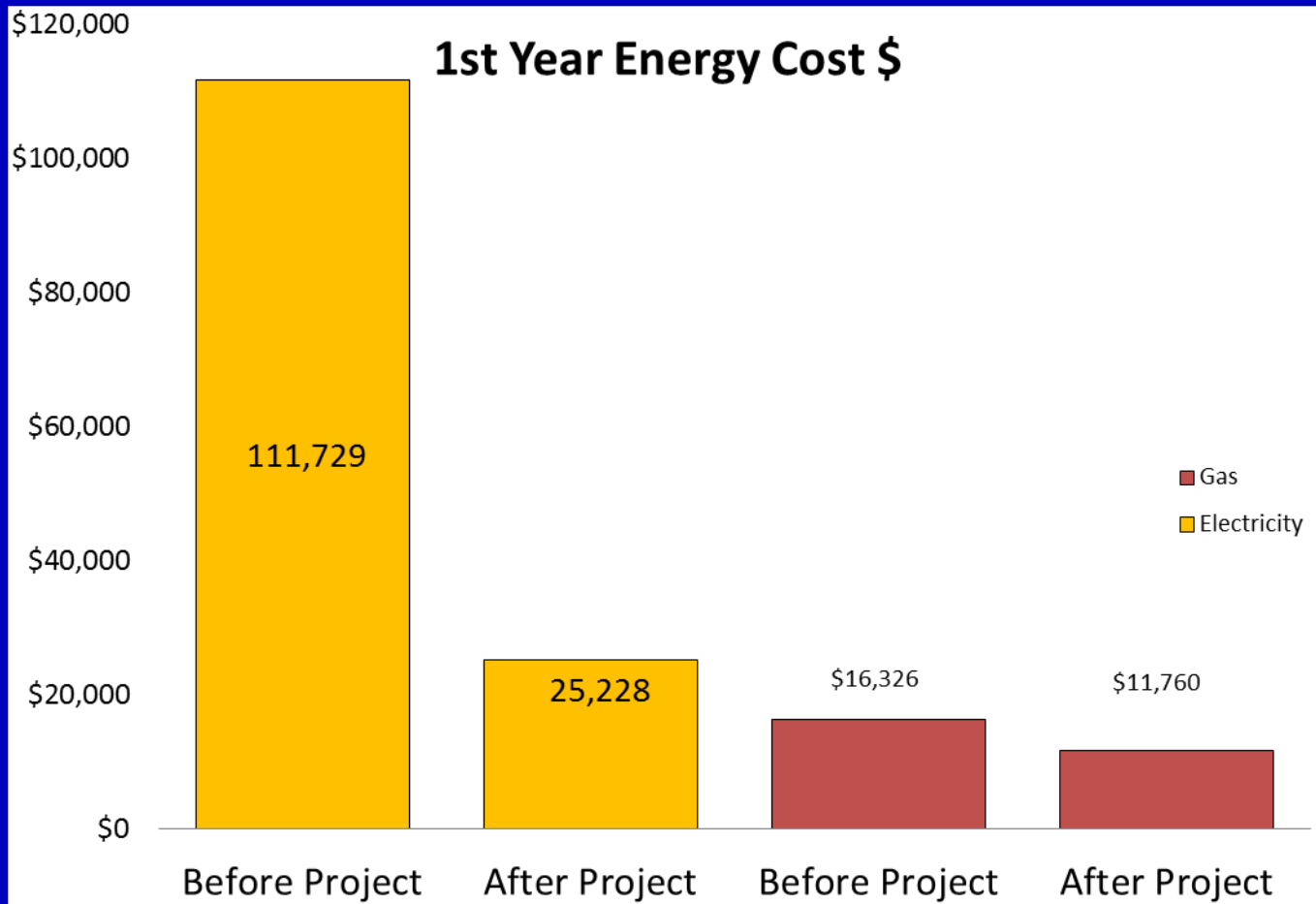

Summary of Selected ECM - Financial

- Total Investment - \$2,404,986
- Year 1 Utility Savings - \$ 107,999
- Year 1 Cash Flow – \$ 184,430
- ROI – 4.2%
- Payback – 12.5 YR
- Property Value Increase - \$ 1,542,842



Case Study - Conservation Before Generation

- Both conservation and generation measures were analyzed in proper order
- Combining conservation and generation presented the opportunity to deliver 72% reduction in utility cost



Conclusions

- Higher building envelope insulation did not make financial sense
- Lower equipment cost and continuous run times will make more financial sense than more energy efficient designs
- Energy generation like solar PV and Thermal has better payback
- LED has huge impact



Conclusions

If performance based approach is used as opposed to prescriptive based:

- Energy generation like solar thermal and solar PV can be used as trade-off
- LED can be used to trade-off

